



SERIES 'E'



MORRIS EIGHT

MORRIS MOTORS LTD COWLEY OXFORD







The
MORRIS
EIGHT
SERIES "E"

OCTOBER, 1938
THIS LIST CANCELS
ALL PREVIOUS LISTS

MORRIS MOTORS LIMITED
VISCOUNT NUFFIELD - - - - *Chairman*
OLIVER BODEN, O.B.E. - - *Vice-Chairman*
COWLEY - OXFORD - ENGLAND



FOREWORD

THE new Morris Eight (Series "E") incorporates in its design many progressive and desirable features of outstanding importance to the owner and is a worthy successor to the amazingly successful Series II model.

The new Morris Eight is in every way a bigger and better car, easily holding its own with the majority of Tens in spaciousness, comfort, performance and luggage accommodation, while definitely outstripping them on the score of economy.

It can truly be said that the new Morris Eight provides for the first time real big car motoring at small car cost.

The engine has been greatly improved by the incorporation of a counterbalanced crankshaft, improved cylinder head, tin-coated pistons, improved lubrication, and re-designed manifolding, while the chassis and bodywork are replete with good features, amongst which may be mentioned the easy-chair type adjustable front seats, four-speed synchromesh gearbox, flush fitting sliding head with concealed drainage, self-cancelling Trafficators, compensated voltage control, inbuilt luggage accommodation, opening windscreen with central control, and the special provisions for rendering the bodywork weatherproof and silent.

Never before has the motoring public been offered such stupendous car value.

The saloon models have greatly increased interior accommodation and convenience which has been achieved without any increase in weight or

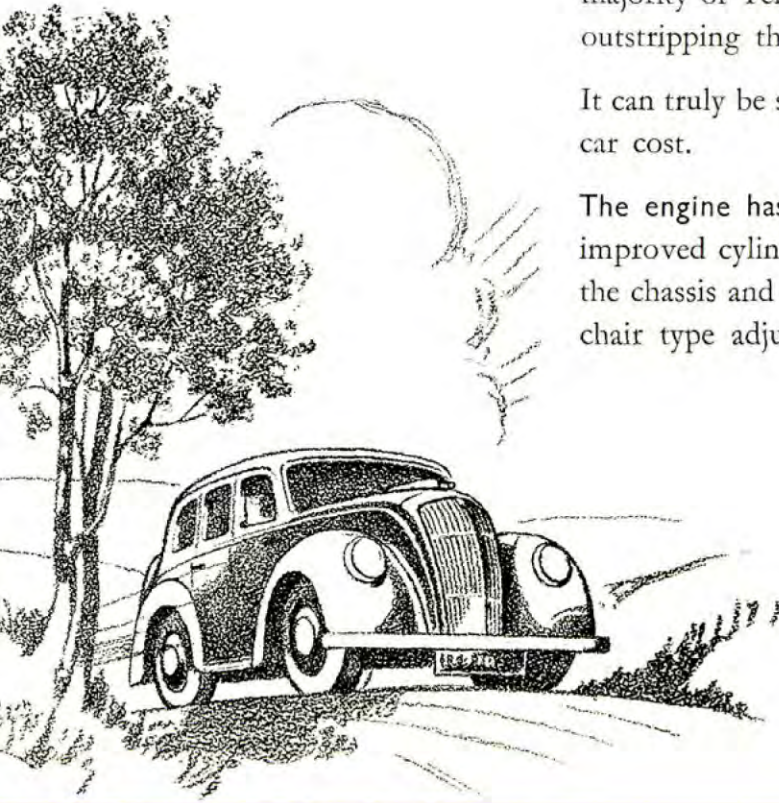

reduction in performance. Indeed, the general performance of the new models on the road shows a distinct advance on the previous series.

The two open models have been vastly improved and are now the most attractive open light cars available to the public. As spacious as the saloon models and with the same degree of comfort, these new open models will meet the requirements of the most fastidious motorist.

Luggage accommodation has been given special consideration on all models and the saloons are provided with large capacity inbuilt luggage containers with convenient external access.

The open models have a large boot whose entire space is devoted to luggage space and in the two-seater model the tonneau is also available for luggage.

The electrical equipment has been amplified by the inclusion of automatic compensated voltage control and self-cancelling Trafficators, thus further reducing the number of items to which the driver must give constant attention, considerably adding to general convenience.

Safety—that increasingly important aspect of motoring—has not been forgotten in the new design, which incorporates a particularly good field of view; dead accurate finger-light Bishop cam steering; dipping headlamps with foot control; self-cancelling Trafficators; fully compensated Lockheed hydraulic brakes; large instruments mounted at high level and provided with anti-glare illumination; particularly good road-holding at all speeds and Triplex toughened glass throughout.

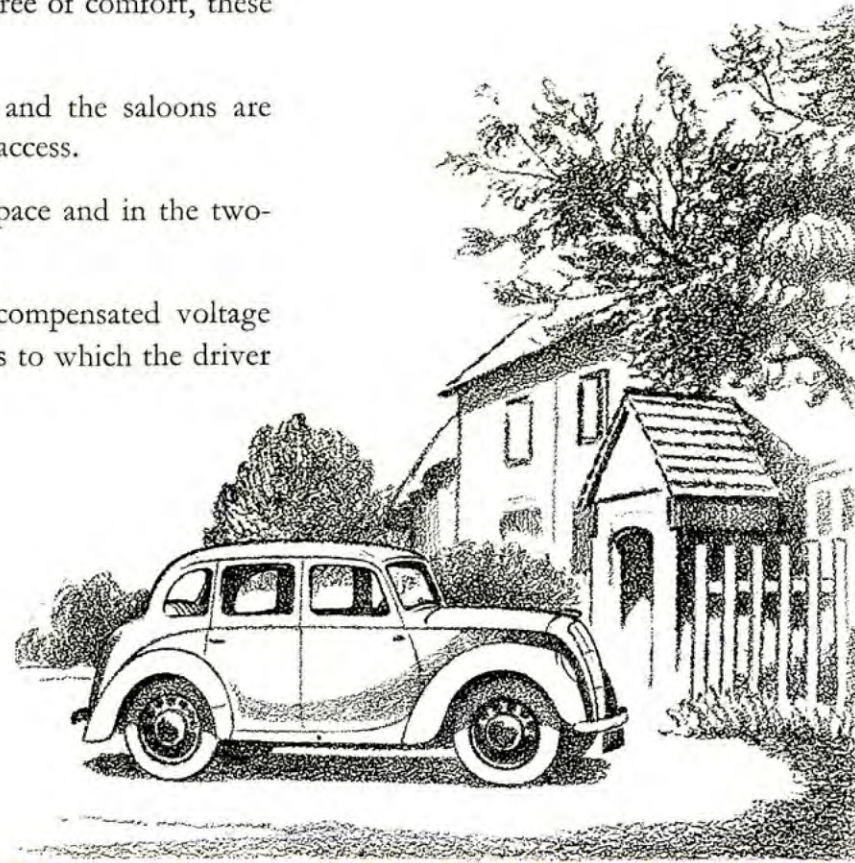

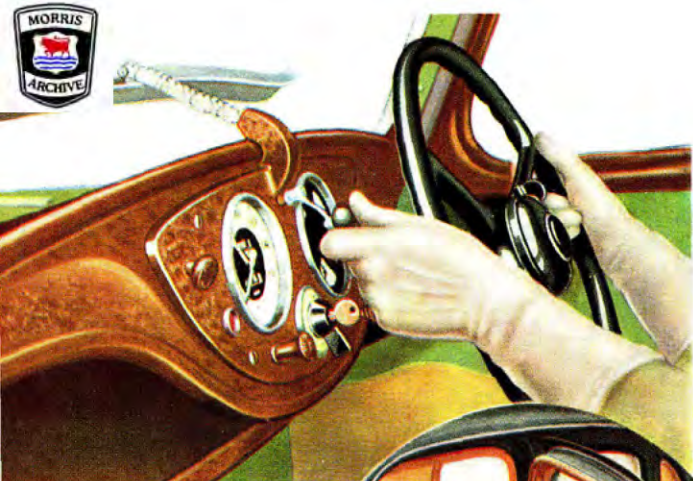

The windscreen has central winding control and opens to a wide angle.

Rubber draught welts are provided on the doors to ensure complete weather-tightness.

The front seats are of the metal framed easy-chair type with floating spring seat base.



OUTSTANDING FEATURES OF

- ▶ Outstanding road performance.
- ▶ Extreme economy.
- ▶ Improved body designs.
- ▶ Improved accommodation.
- ▶ Improved engine with better performance.
- ▶ New four-speed gearbox with synchromesh on second, third and top gears, and silent helical pinions.
- ▶ Superb controllability with exceptionally light and accurate steering which is particularly free from road shock reaction.
- ▶ Well tried semi-elliptic springing controlled by piston-type hydraulic shock absorbers.
- ▶ Sound-insulated bodies free from objectionable drumming and creaks.
- ▶ Attractive range of hard-wearing colours.
- ▶ Floating rubber engine mounting.
- ▶ Tin-coated aluminium alloy pistons, ensuring absence of pick-up and scoring.
- ▶ High efficiency safe braking by the Lockheed hydraulic fully compensated system.
- ▶ Extensive control over ventilation by bottom opening windscreen with central winding control.
- ▶ Engine air silencer.
- ▶ Extensive crankcase ventilation with fume discharge below body.
- ▶ Good ground clearance.
- ▶ Improved intake manifold giving increased power, economy and easy starting.
- ▶ Large inbuilt luggage container with external access on saloons and large luggage boots on the open models.
- ▶ Toughened Triplex glass throughout.
- ▶ Well-less floor.
- ▶ Adjustable easy-chair front seats with floating cushions.
- ▶ Flush-type sliding roof with concealed drainage.
- ▶ Wide doors with concealed metal door stops.
- ▶ Special provision against draughts by rubber draught welts round doors.
- ▶ Special weatherproofing by extended guttering discharging water below doors.



THE NEW MORRIS EIGHT

- ▶ Improved facia board with conveniently grouped instruments having high location for ease of vision.
- ▶ Projection-free hand brake with simple adjustment from driver's seat and fully enclosed grease-packed cables.
- ▶ Windscreen wiper with silent remote drive on saloons.
- ▶ Large parcel tray with level floor extending full width of car beneath facia board.
- ▶ Good rear vision by internal mirror and large rear light on closed models.
- ▶ Windscreen carefully sloped to reduce glare to a minimum.
- ▶ Counterbalanced crankshaft with steel backed main and big-end bearings.
- ▶ High capacity engine lubrication.
- ▶ Single-plate dry clutch with light action and smooth pick-up.
- ▶ Sturdy rear axle assembled by a scientific system of pre-selection and erection.
- ▶ Locked bonnet with hinged top.
- ▶ Spring anchorage by silent-bloc bushes; shackles fitted with screwed type bushes.
- ▶ Improved spoked disc easy-clean wheels with snap-on covers and six-stud fixing.
- ▶ Six-volt battery with positive earth wiring. Battery mounted on dash.
- ▶ All-weather protection for brake gear.
- ▶ Generous mudguarding of modern design.
- ▶ Improved type of corner jack.
- ▶ Self-cancelling Trafficators with wheel centre control.
- ▶ One-piece exhaust system rubber-insulated from frame.
- ▶ Large dynamo with compensated voltage control.
- ▶ Powerful inbuilt headlamps with dip and switch with foot control and pilot side bulbs.
- ▶ Automatic ignition control.
- ▶ Rear blind on closed models with remote control.
- ▶ Anti-fraying, rubber inserted pile carpets.
- ▶ Full width bumpers front and rear.
- ▶ Large low-pressure tyres.
- ▶ Improved number-plate illumination with reflector device^o to facilitate reversing.



The open models are provided with ample luggage space in the boot, the two-seater model having additional luggage accommodation in the tonneau.

The roof guttering is carried right down below the doors to discharge rain water into the road.

A large parcel tray, with level floor, running the whole width of the car, is fitted to all models.

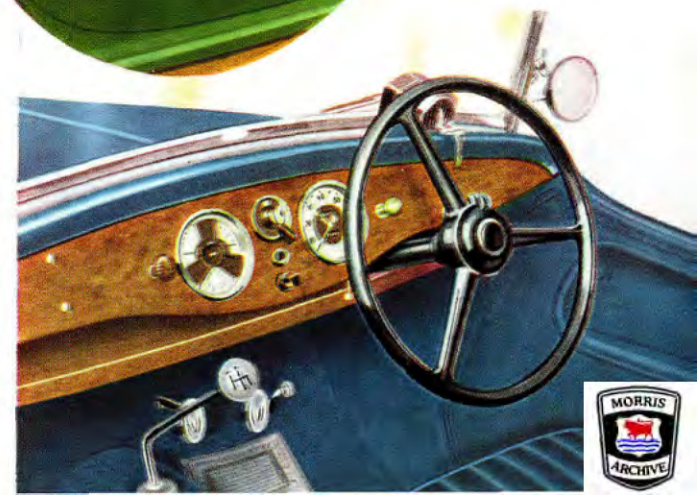

THE MORRIS EIGHT (SERIES "E") OPEN MODELS

WITH saloon comfort and spaciousness, these open models ensure maximum riding ease and complete absence of fatigue on long journeys, while their effective all-weather equipment renders them particularly serviceable in bad weather conditions.

The touring model accommodates four people in easy comfort and has ample space for luggage in the boot, access to which is obtained by the removable rear seat back. The two-seater has additional luggage accommodation in the spacious tonneau and thus possesses exceptional luggage capacity. Both models are fitted with adjustable tilting easy-chair front seats to facilitate access to the rear.

The Morris Eight (Series "E") two-seater and touring models are obtainable finished in any of the four attractive colour schemes shown on page 20. The upholstery is in Karhyde.

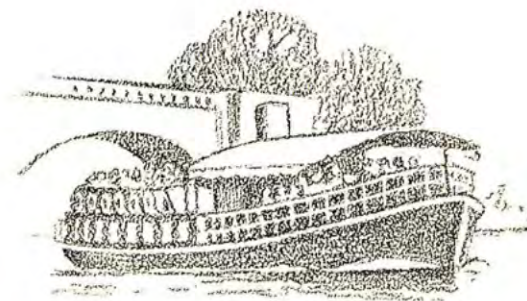
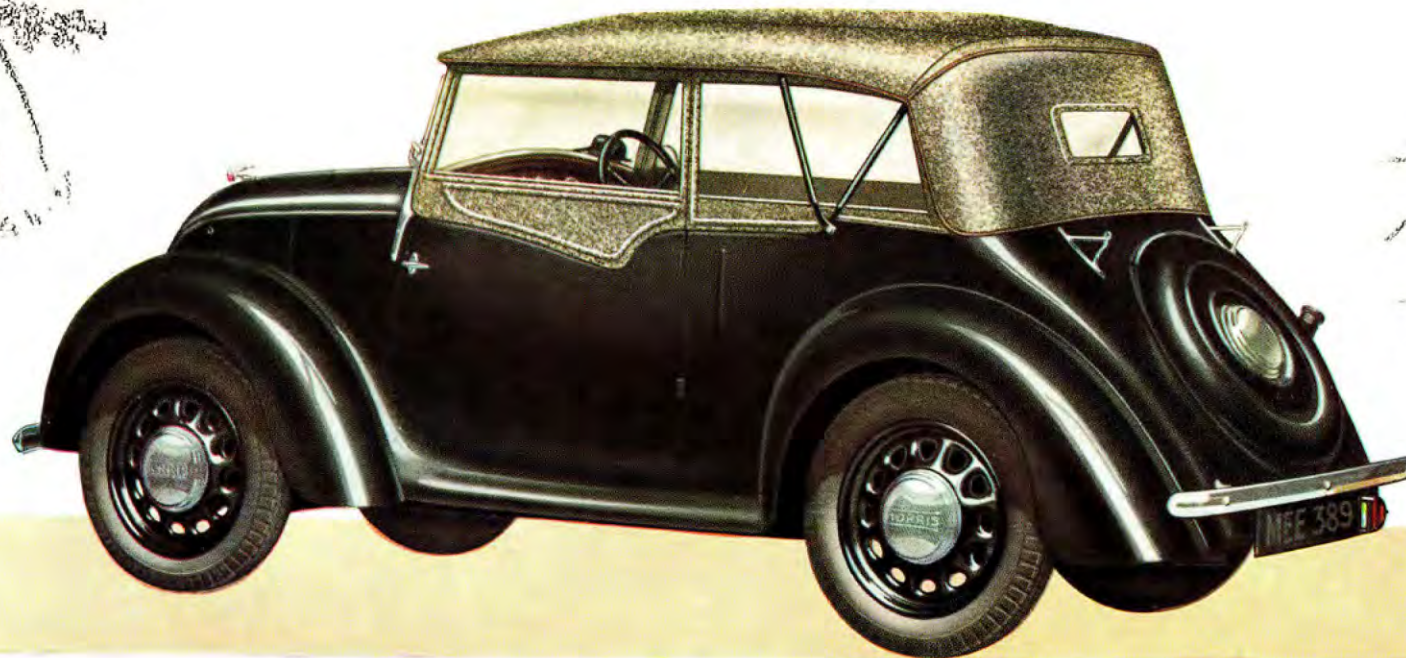



PRICES

TWO-SEATER £132 10s.

TOURER £135 0s.

METAL SPARE WHEEL COVER ON BLACK MODELS 20/- EXTRA
" " " " COLOURED " 27/6 "

(Prices ex Works)

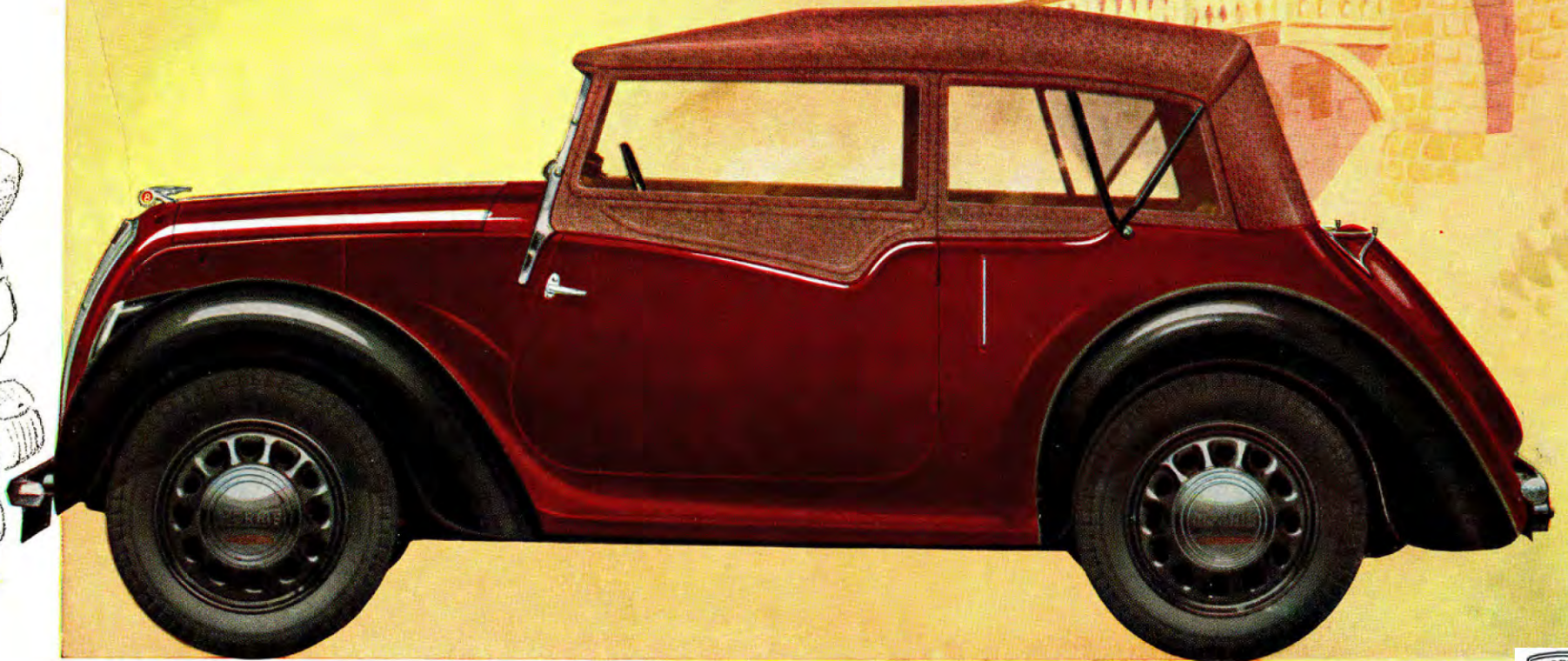



THE MORRIS EIGHT (SERIES "E") TWO-DOOR SALOON

DESIGNED to meet the requirements of those who desire a saloon car with a high degree of comfort for two persons and equally comfortable seating for two additional passengers on occasion, this Morris model provides the most economical closed car motoring available to-day.

Attractive in appearance, with wide doors giving easy access to the front seats, commodious inbuilt luggage accommodation having external access, and seating space above the ordinary for a car of this horse-power, the Morris Eight two-door saloon is remarkable value.

It is available either as a fixed head or sliding head model, finished in any of the four attractive colour schemes shown on page 20. The sliding head model has leather upholstery. The fixed head model has Karhyde upholstery.

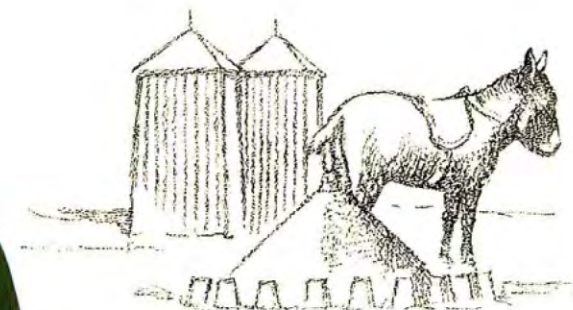
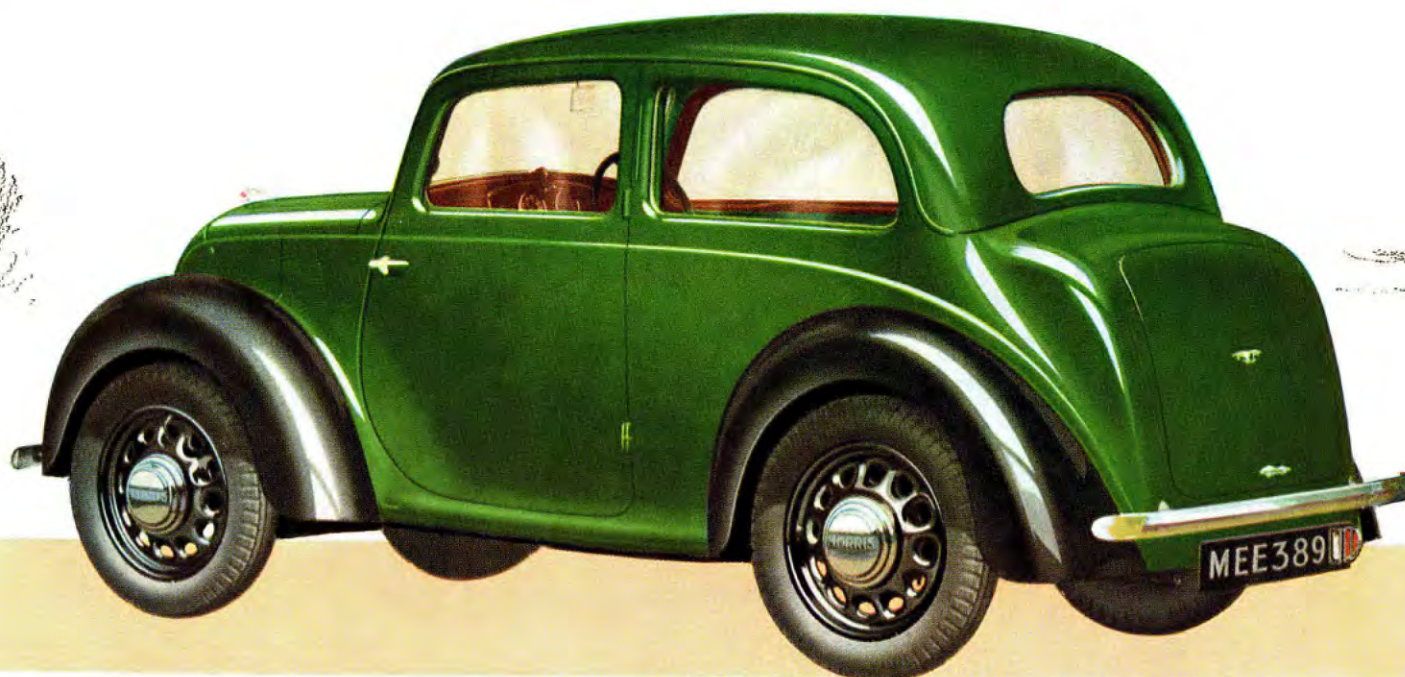



PRICES

TWO-DOOR SALOON (FIXED HEAD) . £128

TWO-DOOR SALOON (SLIDING HEAD) . £139

(Prices ex Works)

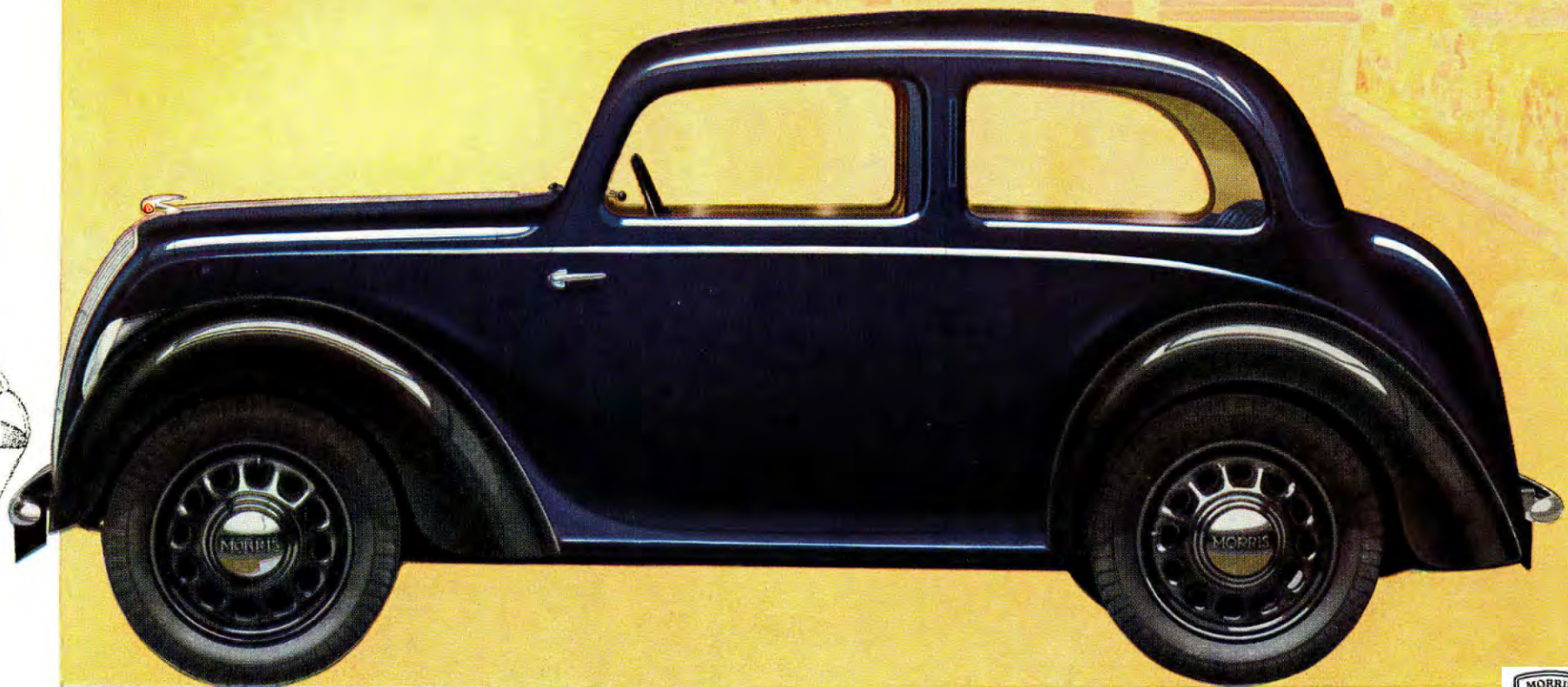



THE MORRIS EIGHT (SERIES "E") FOUR-DOOR SALOON

THE Morris Eight (Series "E") Four-Door Saloon is the economy car which the family man of moderate means has been looking for. Fast, comfortable and safe, with interior accommodation equal to most Tens, it is capable of meeting the most exacting requirements.

Exceptional leg and head room is provided for four people, while the width of the new model is such that a rear seat 47 in. wide at elbow has been incorporated. Luggage accommodation—so important to the family man—has been well considered and an inbuilt luggage container with external access is provided, having a capacity of nearly $5\frac{1}{2}$ cubic feet; enough for your week-end journeys.

The Morris Eight Four-door Saloon is obtainable in any of the four durable colour schemes shown on page 20 with either a sliding or fixed head. The sliding head saloon has leather upholstery. The fixed head saloon has Karhyde upholstery.

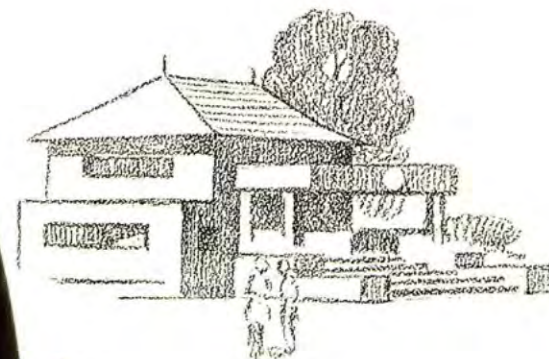



PRICES

FOUR-DOOR SALOON (FIXED HEAD) . . . £139
FOUR-DOOR SALOON (SLIDING HEAD) . . . £149

(Prices ex Works)

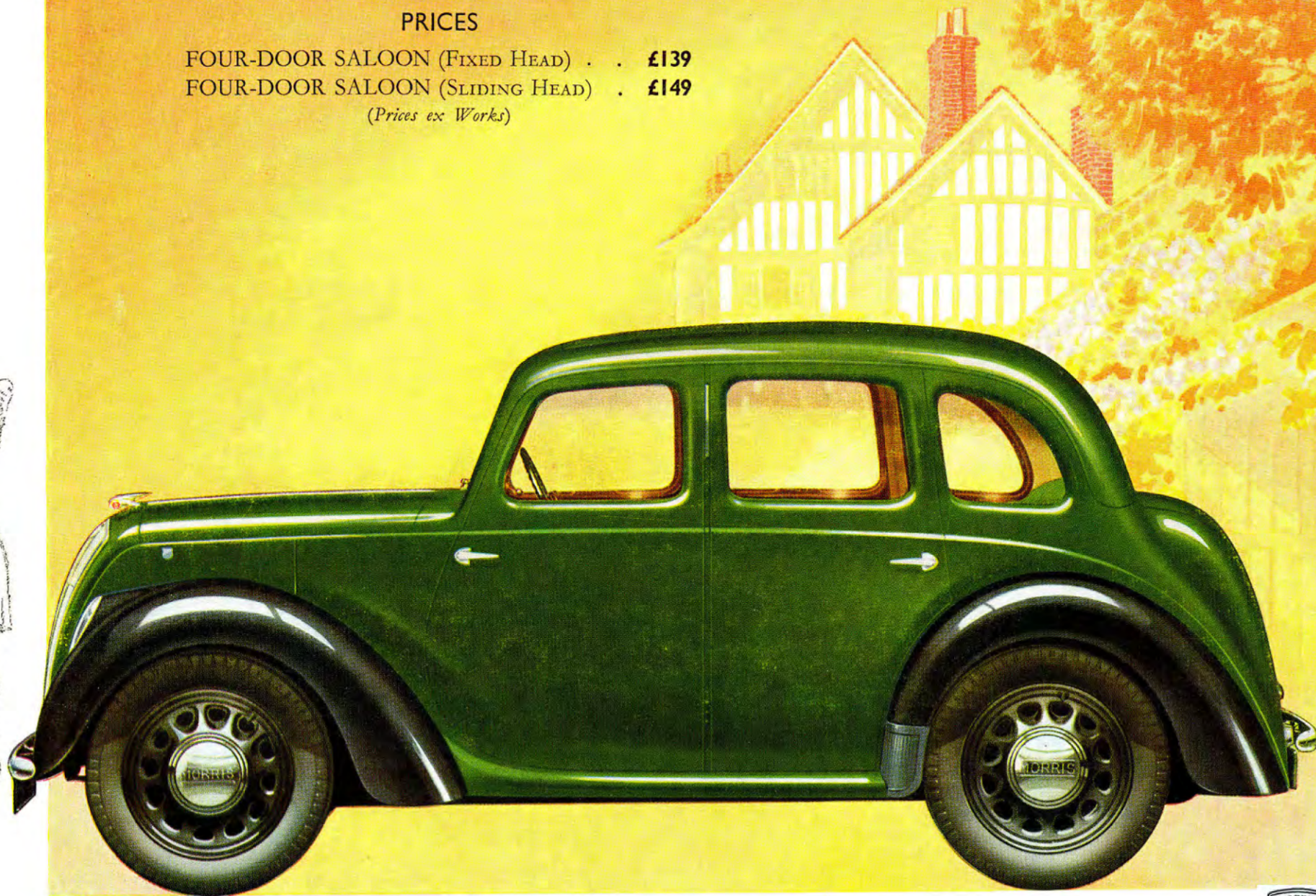

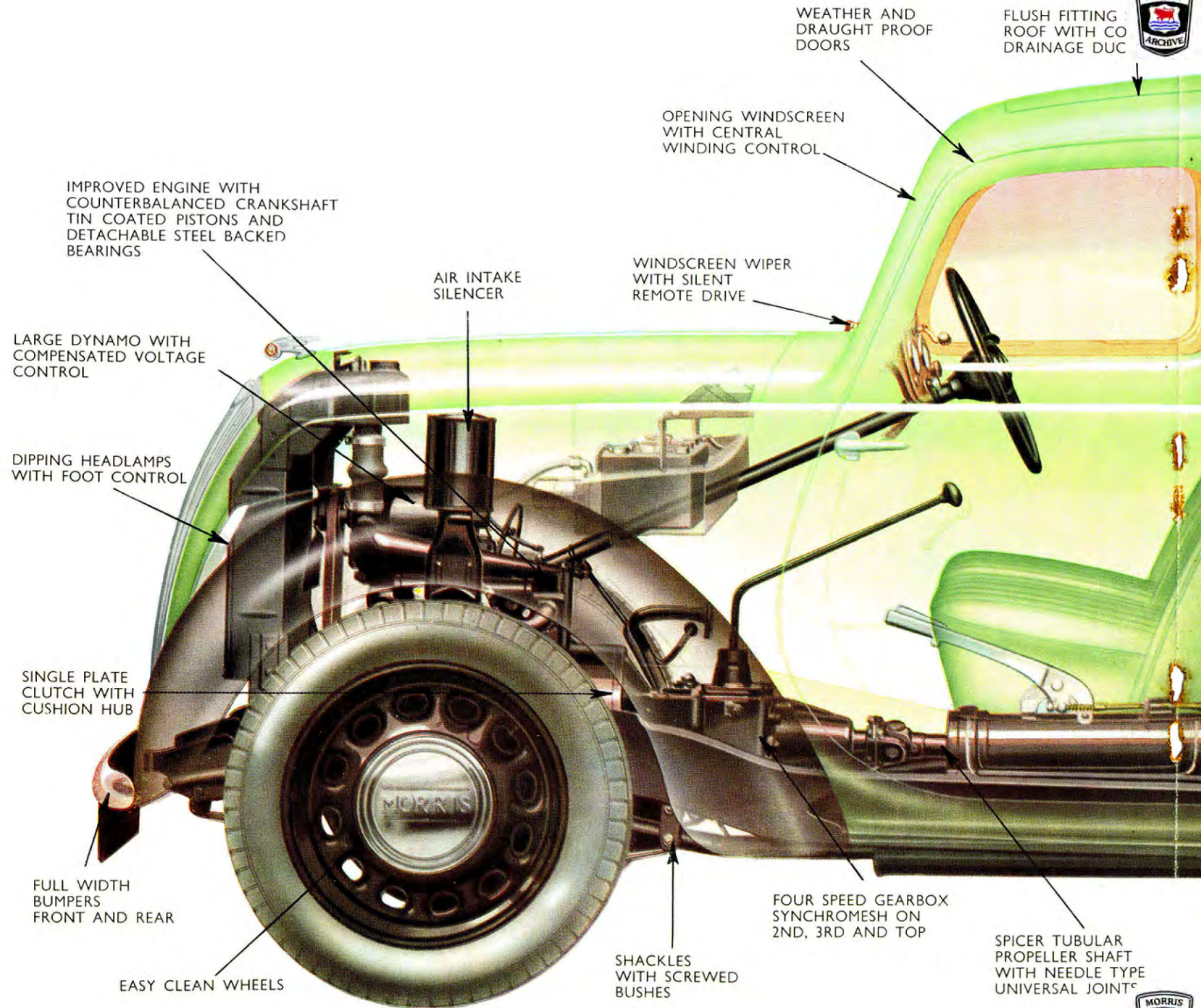

WEATHER AND
DRAUGHT PROOF
DOORS

FLUSH FITTING :
ROOF WITH CO
DRAINAGE DUC

OPENING WINDSCREEN
WITH CENTRAL
WINDING CONTROL

IMPROVED ENGINE WITH
COUNTERBALANCED CRANKSHAFT
TIN COATED PISTONS AND
DETACHABLE STEEL BACKED
BEARINGS

WINDSCREEN WIPER
WITH SILENT
REMOTE DRIVE

AIR INTAKE
SILENCER

LARGE DYNAMO WITH
COMPENSATED VOLTAGE
CONTROL

DIPPING HEADLAMPS
WITH FOOT CONTROL

SINGLE PLATE
CLUTCH WITH
CUSHION HUB

FULL WIDTH
BUMPERS
FRONT AND REAR

EASY CLEAN WHEELS

SHACKLES
WITH SCREWED
BUSHES

FOUR SPEED GEARBOX
SYNCHROMESH ON
2ND, 3RD AND TOP

SPICER TUBULAR
PROPELLER SHAFT
WITH NEEDLE TYPE
UNIVERSAL JOINT[®]



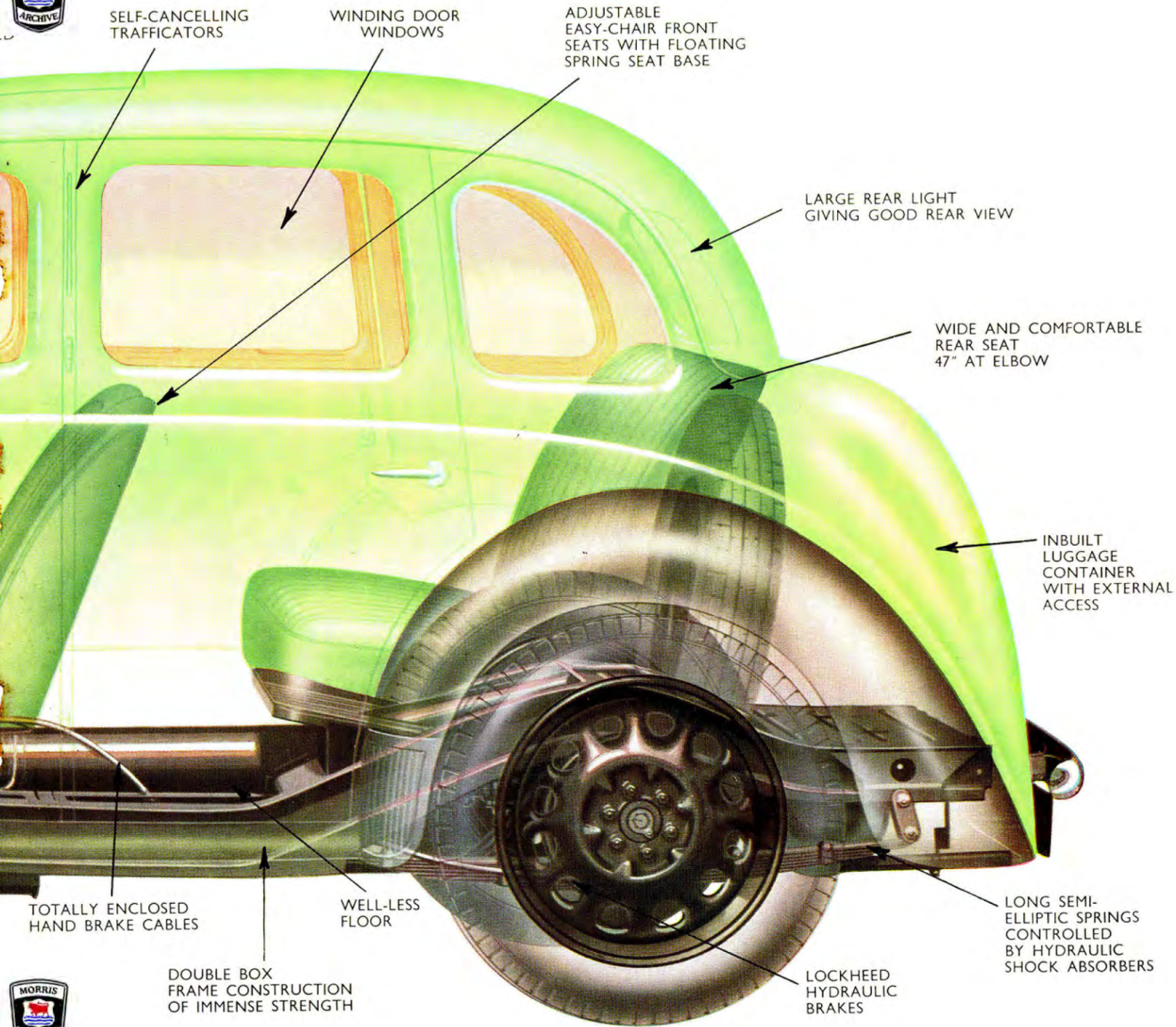

SELF-CANCELLING
TRAFFICATORS

WINDING DOOR
WINDOWS

ADJUSTABLE
EASY-CHAIR FRONT
SEATS WITH FLOATING
SPRING SEAT BASE

LARGE REAR LIGHT
GIVING GOOD REAR VIEW

WIDE AND COMFORTABLE
REAR SEAT
47" AT ELBOW

INBUILT
LUGGAGE
CONTAINER
WITH EXTERNAL
ACCESS

TOTALLY ENCLOSED
HAND BRAKE CABLES

WELL-LESS
FLOOR

DOUBLE BOX
FRAME CONSTRUCTION
OF IMMENSE STRENGTH

LOCKHEED
HYDRAULIC
BRAKES

LONG SEMI-
ELLIPTIC SPRINGS
CONTROLLED
BY HYDRAULIC
SHOCK ABSORBERS





The interior of the Morris Eight (Series "E") is particularly roomy and well conceived for a car of this horse-power. Note the width of the rear seat, the easy-chair front seats, and the well-less floor.



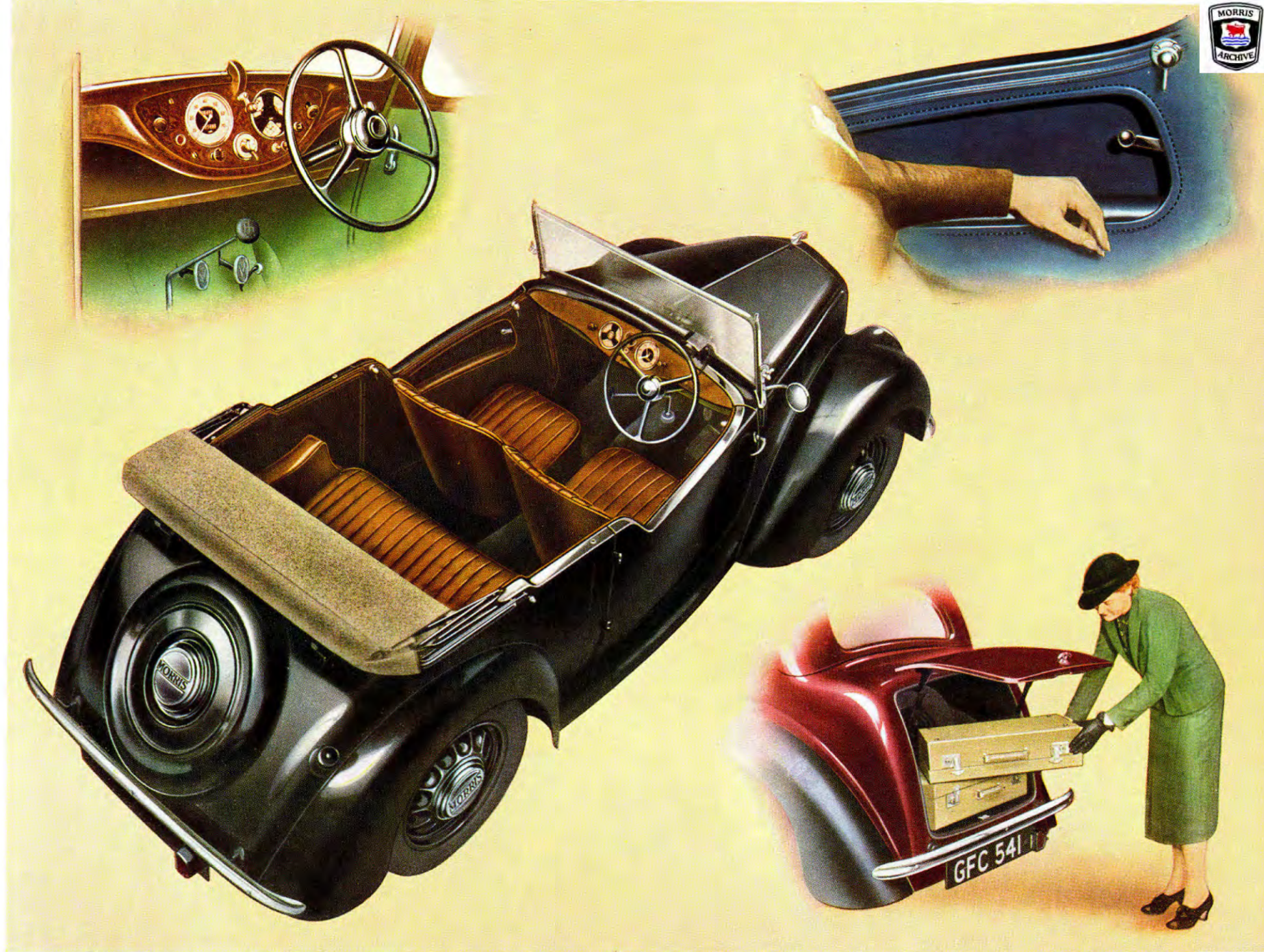

The new Morris Eight (Series "E") is replete with refinements, including inbuilt luggage accommodation, attractive and practical fascia boards, and exceptionally comfortable seating arrangements.



SPECIFICATION

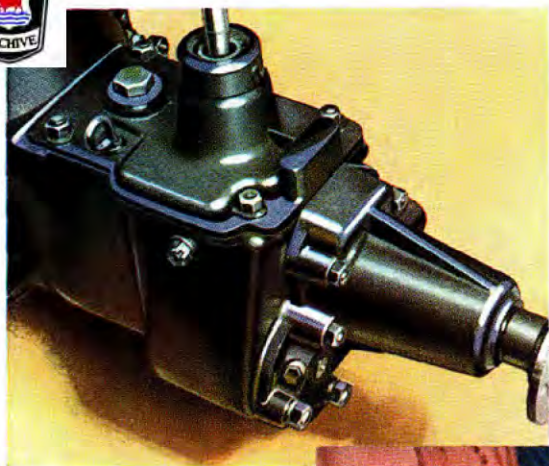

The new four-speed gearbox has synchromesh engagement for 2nd, 3rd and top gears, and is provided with silent helical gears.

The driver's seat of the four-door saloon is instantly adjustable for position, while the passenger's seat can also be adjusted. On the two-door saloon and open models the front seats are of the tip-up adjustable type.



Reliable semi-elliptic springs of excellent length, controlled by up-to-date hydraulic shock absorbers, ensure the maximum comfort combined with safety.

GENERAL CONSTRUCTION. The new Morris Eight (Series "E") consists of a powerful side-valve engine built in unit construction with a four-speed synchromesh gearbox, mounted on a chassis of advanced design, with double-box section side members of exceptional strength.

Transmission is by Spicer tubular propeller shaft with needle type universal joints and the rear axle is of the three-quarter floating type with spiral bevel final reduction gears and differential. Suspension is by improved semi-elliptic springs, controlled by piston type hydraulic shock absorbers. The wheelbase is 7 ft. 5 in. and the track 3 ft. 8 $\frac{1}{2}$ in. at the front and 3 ft. 10 $\frac{1}{4}$ in. at the rear.

ENGINE. The four-cylinder side-valve engine of the Morris Eight (Series "E") possesses a bore of 57 mm. and a stroke of 90 mm. (3.54 in.), giving a cubic capacity of 918 c.c. and a Treasury rating of 8.05 h.p. with a tax of £6.

The cylinders are cast in one with the skirt of the crankcase, which is liberally reinforced with internal webs to provide a structure of great strength and rigidity. The crankshaft is of the counterbalanced type with three large bearings ensuring freedom from vibration. Every crankshaft is carefully balanced to very close limits, and the main bearings have steel backed white metal liners.

The connecting rods are of steel with full-ring steel backed replaceable white metal bearings. They are carefully balanced individually and the complete assemblies of connecting rods and pistons are equalised in weight to within 0.2 oz., as in best aero engine practice.

The pistons are of low expansion aluminium alloy, and they are fitted with three rings—two compression and one oil control. The pistons are tin-coated to ensure freedom from "pick-up" and have split skirts.

The valves are operated from a three-bearing camshaft situated in the upper portion of the crankcase. The camshaft is driven by a silent duplex roller chain which provides a trouble-free drive possessing very long life.

Hollow chill cast tappets of large diameter are fitted.

Valve adjustment is by adjustable screws on the valve tappets.

There is a large breather pipe discharging well below the body which ensures perfect crankcase ventilation and avoids condensation.

The engine is mounted on the chassis by floating rubber connections which effectively damp out the least trace of engine vibration, and the one-piece exhaust system is also rubber insulated.

SYNCHROMESH GEARBOX. The four-speed gearbox is provided with synchromesh engagement for second, third and fourth gears, which are of the silent helical type. The gearbox is fitted with an accessible filling orifice and a dipstick oil level indicator. The gear ratios are: 1st, 20.88; 2nd, 12.158; 3rd, 8.140; 4th, 5.286; reverse, 20.88.

LUBRICATION SYSTEM. A large spur gear pump located in the sump and driven by helical gears from the camshaft supplies oil under pressure to all main bearings, big-end bearings and camshaft bearings. The delivery from the oil pump is sufficiently large to ensure adequate lubrication, even under unfavourable conditions.

The oil intake in the sump is protected by a metal shield and extended oil intake pipe, and also provided with a cylindrical gauze filter. The pump is fitted with a non-adjustable relief valve. The chassis is lubricated by high pressure oilgun and accessibly located nipples.



COOLING SYSTEM. The cooling water is circulated by thermo-syphon action. The water passages are carefully proportioned to ensure even cooling. A cooling fan is fitted.

CARBURATION. An S.U. automatic piston type carburetter, with adequate control over mixture strength for easy starting, supplies the working mixture. The mixture control is conveniently mounted on the fascia board and is inter-connected with the throttle control so that the correct throttle opening for slow running when cold is obtained automatically. The carburetter is provided with an efficient air silencer. Particular attention has been given to the carburation system with a view to giving maximum economy without the sacrifice of performance. The improved induction manifold provides better distribution and is provided with an adequate "hot-spot." The fuel feed is by S.U. automatic electric pressure petrol pump.

PETROL TANK. The petrol tank is mounted at the rear of the chassis and has a capacity of $5\frac{1}{2}$ gallons. Its contents are clearly indicated by an electrically operated gauge on the fascia board, and the tank is fitted with a large vent to facilitate rapid filling.

TRANSMISSION. A single-plate dry clutch with cushion hub and single-point adjustment provides smooth engagement with light action and the minimum attention. A Spicer tubular propeller shaft with needle type universal joints at each end serves to transmit the drive to the rear axle.

REAR AXLE. The rear axle is of the three-quarter floating type with spiral bevel final reduction gears. A scientific system of gear selection and assembly is employed to ensure maximum efficiency.

FOUR-WHEEL BRAKES. Fully compensated foot brakes of the internally expanding type, operated by the Lockheed hydraulic system, ensure the maximum possible braking efficiency. Their certainty of action is maintained under all conditions, as there are no bearings to wear or need lubrication, or cables to stretch. The brake-shoes are of steel, and lined with high efficiency linings. The hand brake is provided with adjustment from the driver's seat and operates on the rear wheels by cables totally enclosed in grease packed conduits. Special provision has been made to protect the brake gear against the weather.

STEERING. The steering gear is of the cam type and careful design of all the steering components has resulted in exceptionally light steering which is particularly suited to lady drivers. In spite of the lightness of the steering, it is precise in action and free from any tendency to wander. The steering is also particularly free from road shock reaction.

SUSPENSION. Semi-elliptic springs of great length are fitted fore and aft and are controlled by hydraulic piston-type shock absorbers. The front spring eyes are fitted with silent-bloc bushes, and the shackle pins at the rear ends of the springs are fitted with screwed bushes, ensuring long life and the minimum of service attention.

WHEELS. Five detachable spoked-disc easy-clean wheels with Dunlop tyres (4.50—17) are fitted. The wheels are held in position by six studs with nuts of the reversible type and are fitted with snap-on hub covers. The spare wheel is carried in a separate compartment at the rear and is completely protected from the weather. It is easily removed.



The power unit of the new Morris Eight (Series "E") has been improved by the fitting of a balanced crankshaft, improved cylinder head, tin-coated pistons, and a modified carburation system.



A characteristic feature of the new Morris Eight is the splendid interior accommodation provided. The rear seat on the saloon models is no less than 47 in. wide at the elbow.

Self-cancelling Trafficators with wheel centre control is provided on all models, contributing to the driver's convenience and general road safety.



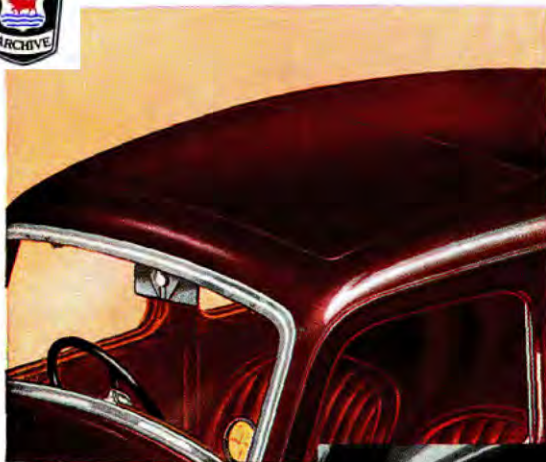

The sliding head saloon models are fitted with a flush fitting sliding head with concealed guttering discharging water below the car.

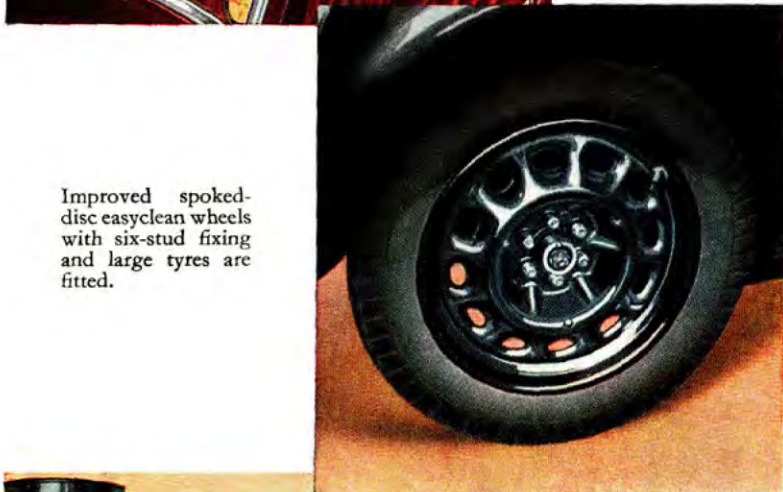

Improved spoked-disc easyclean wheels with six-stud fixing and large tyres are fitted.

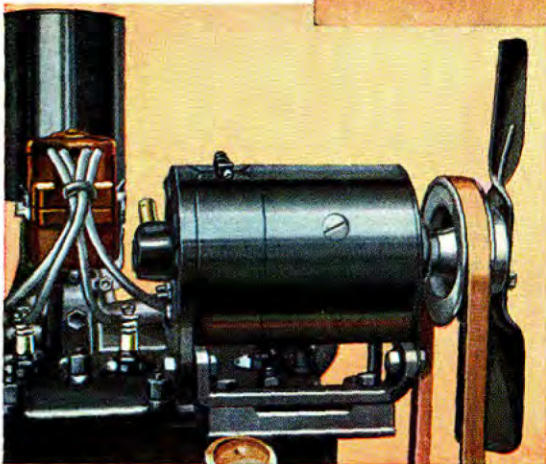

The dynamo is of large dimensions and provided with compensated voltage control which relieves the driver from regulating its output.

VENTILATION. Special care has been taken to ensure adequate ventilation. The windscreen on the saloons has top hinges and is adjustable up to a wide opening by a single central control of the winding type. The windscreen can be opened to a wide angle for clear vision in fog.

On the saloons all door-windows are of the winding type. On the open models the windscreen can be folded flat on to the top of the scuttle for clear vision.

SEATING ACCOMMODATION. The front seats are built on a steel framework with a floating spring foundation for the upholstery, ensuring the maximum riding comfort. The driving seat of the four-door saloon is mounted on flush type runners and has a simple and positive means for adjusting the position. The passenger's seat is also adjustable for position.

Exceptionally good leg room is provided for the rear passengers, while the wide rear seat is upholstered on particularly generous lines and has an elbow width of 47 in.

In the case of the two-door saloon and open models both front seats are hinged in addition to being adjustable.

JACKING SYSTEM. The standard jack equipment consists of a special corner jack adapted to hook under the bumper bar brackets and is equipped with a screwed shaft which can be actuated by the wheel brace. This jack is conveniently housed on the dash.

LUGGAGE ACCOMMODATION. The new Morris Eight (Series "E") is fitted with a large inbuilt luggage compartment with external access by a large hinged lid. With the lid closed, the space available for storage is nearly $5\frac{1}{2}$ cubic feet.

Special provision has been made to render the luggage compartment watertight. In addition there is a large parcel tray beneath the fascia board which extends the full width of the car. This parcel tray has a level floor.

ELECTRICAL EQUIPMENT. The electrical equipment is of the 6-volt type. The distributor has automatic advance and retard control and is driven from the camshaft by helical gears.

The large dynamo is belt driven and is fitted with compensated voltage control.

The positive earth system of wiring is employed.

The starter motor is of ample capacity to ensure an instantaneous start under the most trying conditions, and its engagement is by sliding pinion. The starter switch is hand operated and located on the fascia board.

Special three-lamp equipment is provided, including sunk headlamps with dip and switch mechanism operated by a single-acting foot-controlled switch which dips the lights on one depression and raises them on the next. The sidelamp bulbs are incorporated in the headlamps.

The horn push and self-cancelling Trafficator switches are mounted in the centre of the steering wheel, while all other switches are accessibly mounted on the fascia board within easy reach of the driver.

An easily controlled windscreen wiper with silent drive and motor located on the engine side of the dash is fitted to the saloons. On the open models the electric wiper is mounted at the top of the windscreen.

The single large 6-volt battery is mounted under the bonnet on the dash bulkhead. It is easily accessible and is provided with non-spilling vents.

An automatically actuated stop light is part of the equipment.

THE BODY. The floor is devoid of footwells and the interior is unusually spacious for a car of this horse-power.

Great care has been taken to prevent noise, draughts and the ingress of water. The body is scientifically lined with sound-deadening material, and the front of the body is constructed so as to isolate the body from engine heat and fumes.

The doors are fitted with an efficient rubber draught sealing strip, and the roof guttering is carried right down in front of the door opening to discharge rain water well below the door. Door-window garnish frames are prepared in modern plastic material of attractive appearance and great durability, with fascia board to match.

Pile carpets of the anti-fraying rubber inserted type cover the floor, while the interior upholstery is carried out in simple but pleasing style, and is particularly comfortable.

The instrument equipment includes oil gauge, speedometer and electric petrol gauge, all of which are provided with translucent indirect illumination.

The open models are provided with a neat hood and detachable sidescreens which are conveniently housed in a carrier in the boot when not in use.

The tourer body has spacious accommodation for luggage in the boot behind the rear seat, and in the two-seater body exceptional space is available for luggage.

The two-seater model is provided with a tonneau cover.

The sliding head saloons are fitted with a flush fitting roof and concealed drainage ducts which discharge rain water below the car.

GENERAL EQUIPMENT. Lockheed hydraulic brakes; pile carpets; gearbox draught excluder; dial-type speedometer; oil gauge; S.U. electric pressure petrol pump; dash-reading electric petrol gauge; electric windscreen wiper; licence holder; pressure chassis lubricating pump; electric horn; electric lighting and starting; headlamps with dipping mechanism and pilot bulbs; stop lamp; self-cancelling Trafficators; bumpers front and rear; hydraulic shock absorbers; five detachable spoked disc easy-clean wheels; five Dunlop cord tyres; tyre pump; kit of tools; spare tin of oil.

Supplementary Equipment on Four-Door Saloon (F.H.). Single-panel adjustable windscreen and winding door-windows of toughened Triplex glass, interior driving mirror, rear blind with remote control, private locks to doors, easy-chair type front seats, sliding driver's seat, adjustable passenger's seat, inbuilt luggage container.

Supplementary Equipment on Four-Door Saloon (S.H.). Flush sliding head, single-panel adjustable windscreen and winding door-windows with toughened Triplex glass, interior driving mirror, rear blind with remote control, private locks to doors, easy-chair type front seats, sliding driver's seat, adjustable passenger's seat, inbuilt luggage container.

Supplementary Equipment on Two-Door Saloon (F.H.). Single-panel adjustable windscreen and winding door-windows of toughened Triplex glass, interior driving mirror, rear blind with remote control, easy-chair type tip-up adjustable front seats, private locks to doors, inbuilt luggage container.

Supplementary Equipment on Two-Door Saloon (S.H.). Flush sliding head, single-panel adjustable windscreen and winding door-windows with toughened Triplex glass, interior driving mirror, rear blind with remote control, easy-chair type tip-up adjustable front seats, private locks to doors, inbuilt luggage container.

Supplementary Equipment on Tourer. Folding toughened Triplex glass windscreen, hood, hood bag, detachable sidescreens, exterior driving mirror, adjustable hinged easy-chair type seats, luggage boot.

Supplementary Equipment on Two-Seater. Folding toughened Triplex glass windscreen, hood, hood bag, detachable sidescreens, exterior driving mirror, adjustable tip-up easy-chair seats, tonneau cover, luggage boot.

This specification is liable to alteration at any time.

The driving position is most comfortable and is easily adjusted to suit drivers of varying stature.

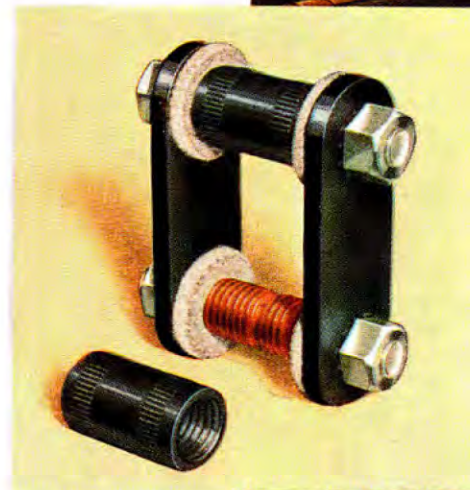

The springs are anchored by "silent-bloc" bearings and have screwed type bushes for the shackles at their rear end, ensuring long life.

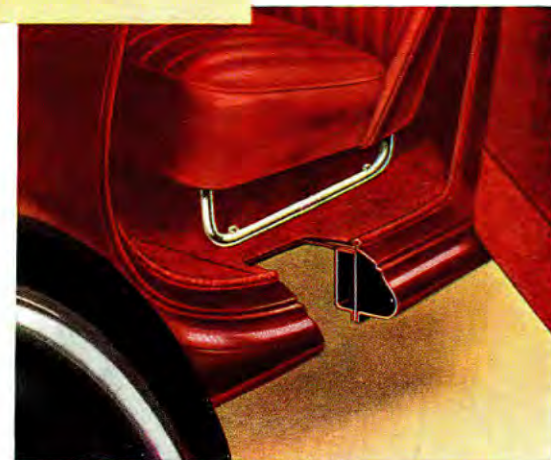

The chassis frame is of box-section, forming with the body sill a double box-section structure of great strength.



BLUE
with Blue upholstery

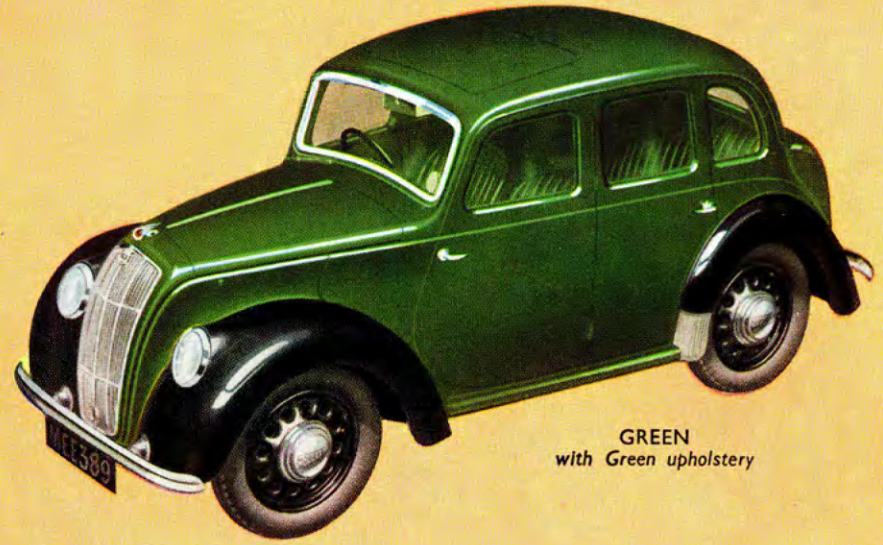

GREEN
with Green upholstery



BLACK
with Brown upholstery

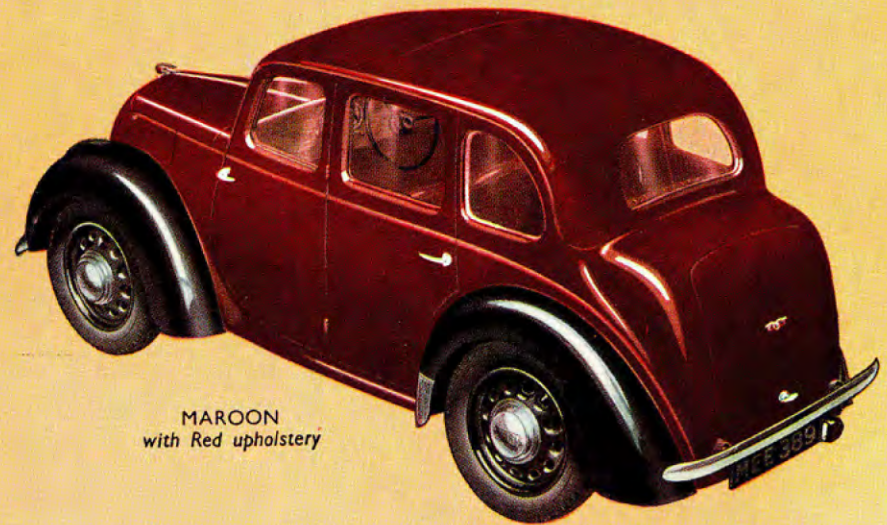

MAROON
with Red upholstery

SEATING DIMENSIONS

SALOON MODELS

OPEN MODELS

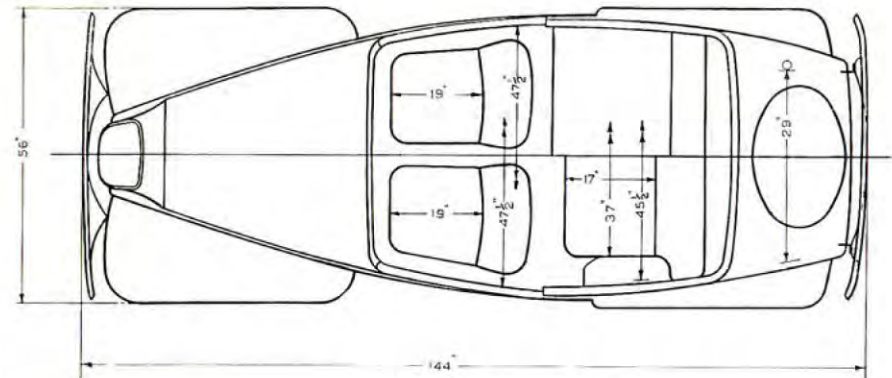
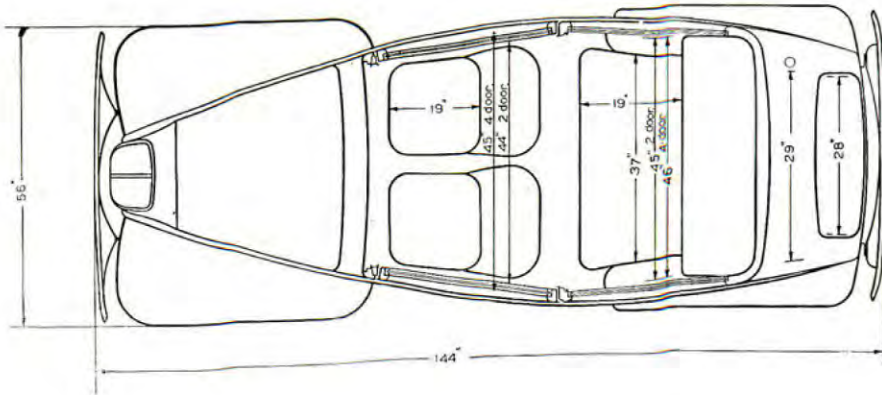
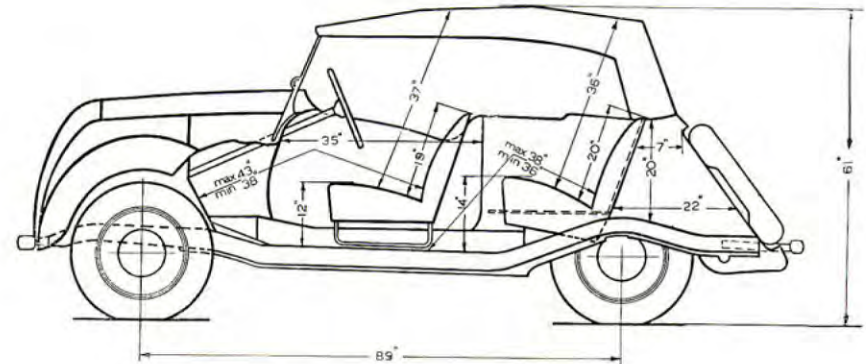
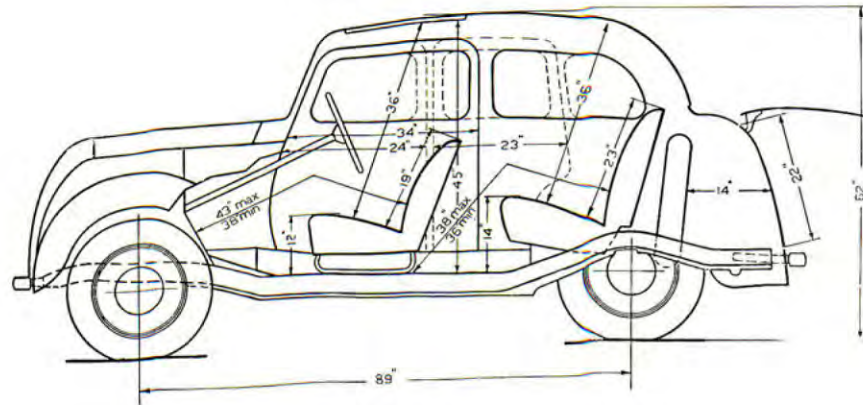

The Morris Eight (Series "E") is an exceptionally roomy car and provides considerably better accommodation than other cars in its class. A comparison of the interior dimensions indicated on the accompanying diagrams will indicate the truth of this statement.



DATA

Bore	57 mm.	2.24 in.
Stroke	90 mm.	3.54 in.
Cubic capacity	918 c.c.	56.02 cu. in.
Treasury rating	8.057	
Tax	£6	
Wheelbase	2.26 metres	89 in.
Track (Front)	1.14 metres	44 $\frac{5}{8}$ in.
„ (Rear)	1.175 metres	46 $\frac{1}{4}$ in.
Tyre size	4.5—17	

Wheel size	2.5 × 17
Gear ratios :	1st 20.88 to 1
Synchronesh {	2nd 12.158 to 1
	3rd 8.14 to 1
	4th 5.286 to 1
	Reverse 20.88 to 1
Sparking plugs	14 mm. Champion L.10
Petrol tank capacity	5 $\frac{1}{2}$ gallons
Overall length	12 ft. 0 in.
Overall width	4 ft. 8 in.
Overall height	5 ft. 2 in.

CHASSIS

For the convenience of those who wish to have their cars fitted with special coachwork to suit their individual requirements, Morris Eight chassis are obtainable separately. These chassis are exceptionally well equipped and include such items as wings, headlamps, instruments, spare wheel and tool kit; in short, they are all ready for the coachwork.

The chassis equipment includes: Dash, pedal rubbers, headlamps with pilot bulbs, dimming switch, stop tail-lamp, battery, front and rear wings (enamelled), front and rear

number-plates, speedometer, oil gauge, electric petrol gauge, electric horn, kit of tools, spare wheel and tyre, hydraulic shock absorbers front and rear, bumpers front and rear, bonnet fitted to chassis complete with fasteners.

PRICE (*ex Works*) **£100**

Purchasers of Morris chassis are requested carefully to note paragraph 3 (f) of Guarantee. No variation in the above chassis specification can be made.





SERVICE

MORRIS SERVICE is as thoroughly specialised as the car production. Morris Motors Limited retain their interest in their cars after they are sold and want to know that you are obtaining the utmost satisfaction and pleasure from their products. The vast Morris Dealer organisation is always at your service, and wherever you may be you can be assured of obtaining the help of proficient Morris specialists when in trouble. During the early life of the car, soon after it has completed 500 miles, you are entitled to have it inspected, free of charge, by the Morris Dealer from whom you purchased it. This attention given during the critical period in the life of the car makes all the difference to its subsequent life and performance. This service includes :—

- (a) Drain sump, gearbox and back axle, and refill with Morrisol "Sirrom" (Regd.) Brand lubricant.
- (b) Oil and grease vehicle throughout with Morrisol "Sirrom" (Regd.) Brand lubricants.

NOTE.—New lubricants chargeable to customers.

- (c) Check and, if necessary, adjust :—
 - (1) Ignition timing.
 - (2) Tappet clearances.
 - (3) Carburetter control gear, mixture setting and slow-running.
 - (4) Dynamo drive belt.
 - (5) Correct clearance for clutch pedal.
 - (6) Alignment of front wheels.
 - (7) All steering controls.
 - (8) Tyre pressures.
- (d) Adjust brakes and check level of Lockheed fluid in supply tank.
- (e) Check correct functioning of Jackall system (when fitted).
- (f) Look over and tighten all nuts, particularly cylinder head, wheels, spring clips and body bolts.
- (g) Top-up battery and check working of all electrical equipment.

All this first service is free, only material used being charged for. Morris Service does not stop here. Morris Motors Limited issue a list of standardised repair charges covering the labour charges for the more usual kind of repairs or overhaul. Thus you can always tell in a few moments exactly what your upkeep costs will be and there need never be any unpleasant disputes concerning the bill presented.

In addition to this Morris Motors give you the benefit of an extensive and attractive reconditioning service whereby fully reconditioned units such as engine, gearbox, front axle, etc., can be obtained in exchange for your old units at the bare cost of reconditioning.

PURCHASE OUT OF INCOME

THERE are a hundred and one reasons why a motorist may prefer to buy his car out of income rather than pay cash for it. For many the practice is undoubtedly a convenience and obviates the necessity of realising capital. On the other hand the motorist wants to feel that the transaction is on an unquestionably sound basis, and is free from troublesome formalities and delays. Therefore Morris Motors Ltd. have selected the United Dominions Trust Ltd. to act as their bankers for hire-purchase work. All Authorised Morris Distributors and Dealers co-operate in this scheme, and you can avail yourself of it locally, wherever you live. The terms are perfectly straightforward and are applicable to any model. You pay a reasonable deposit, preferably not less than a quarter of the total sum. The remainder is then payable in instalments over 12, 18 or 24 months, as you choose. Quarterly instalments can also be arranged.

As an example, supposing that you have chosen a model at £139. You pay a first deposit of, say, £44. The outstanding balance is now £95. If you are paying this off over 12 monthly instalments the sum payable each month would be exactly £8 8s. 7½d. This is inclusive of all interest charges.

When you have fully studied this catalogue and have decided upon the model you prefer, examine the table below and from it you can easily calculate the first deposit and the subsequent monthly instalments. Remember that this scheme holds good for any model. Make up your mind whether you will pay off the balance over 12, 18 or 24 months. Then go to your nearest Morris Distributor or Dealer and advise him. He will carry out the rest.

Balance after deducting Deposit	12 Instalments of	or 18 Instalments of	or 24 Instalments of
£ s. d.	£ s. d.	£ s. d.	£ s. d.
5 0 0	— 8 10½	— 6 1½	— 4 9
6 0 0	— 10 7½	— 7 4½	— 5 8½
7 0 0	— 12 5	— 8 7	— 6 7½
8 0 0	— 14 2½	— 9 9½	— 7 7½
9 0 0	— 15 11½	— 11 0½	— 8 6½
10 0 0	— 17 9	— 12 3	— 9 6
20 0 0	1 15 6	1 4 6	— 19 0
30 0 0	2 13 3	1 16 9	1 8 6
40 0 0	3 11 0	2 9 0	1 18 0
50 0 0	4 8 9	3 1 3	2 7 6
60 0 0	5 6 6	3 13 6	2 17 0
70 0 0	6 4 3	4 5 9	3 6 6
80 0 0	7 2 0	4 18 0	3 16 0
90 0 0	7 19 9	5 10 3	4 5 6
100 0 0	8 17 6	6 2 6	4 15 0
200 0 0	17 15 0	12 5 0	9 10 0
300 0 0	26 12 6	18 7 6	14 5 0

The instalments shown include all interest charges. All business carried out on the Morris Hire-Purchase Plan is treated as confidential and is arranged throughout with the utmost discretion.





GUARANTEE

1. For a period of SIX MONTHS from the date on which a new Morris Car or Chassis is delivered to the first owner-user thereof Morris Motors Limited will exchange or repair any part or parts thereof which needs or need replacement or repair by reason of defective workmanship or defective material. The Company will not be responsible for any expense which the purchaser may incur in removing or having removed or in replacing or having replaced any part or parts to be sent for inspection or in fitting or having fitted any new parts supplied in lieu thereof.
2. No claim for exchange or repair can be considered hereunder unless the person claiming
 - (a) Immediately upon discovery of the alleged defect returns the part or parts complained of to the Company's Works carriage paid.
 - (b) Sends therewith particulars of the chassis number and engine number of the Car or Chassis in question, as shown on the manufacturer's identification plate.
 - (c) Sends also full particulars of the claim and of the reasons therefor, stating in such particulars the date of the purchase and the name and address of the person or firm from whom the Car or Chassis was bought.
 - (d) Refers to this Guarantee.
3. This Guarantee shall not apply to
 - (a) Any accessories or proprietary fittings whatsoever.
 - (b) Any Car or Chassis used
 - (i) As a Hackney Carriage.
 - (ii) For hiring out.
 - (iii) For any purpose other than the private or genuine commercial use of the owner-user.
 - (c) Any defective part or parts which in the opinion of Morris Motors Limited has or have been injured by wear and tear or by any form whatsoever of improper use of or from any alteration whatsoever to the Car or Chassis.
 - (d) Any second-hand Car or part or parts thereof.
 - (e) Anything whatsoever not both manufactured by and sold by the Company.
 - (f) Any part or parts of a Chassis to which a body which in the opinion of the Company is unsuitable has been fitted.
 - (g) Any vehicle in or to which any part not manufactured or sold by Morris Motors Limited has been affixed.
4. The liability of Morris Motors Limited is limited to exchange or repair under Clause 1 hereof. Every form of liability for every form of consequential loss or damage is hereby expressly excluded.
5. This Guarantee is given in lieu of and excludes every condition or warranty, whether statutory or otherwise, whatsoever not herein expressly set out.



TERMS OF BUSINESS

CONDITIONS OF PURCHASE. Purchasers of Morris Cars are hereby informed that such Cars are sold subject only to the terms of the guarantee and to the general conditions of sale herein contained, and on the distinct understanding that the vehicle purchased shall not be exhibited, either directly or indirectly, at any exhibition or show held in the United Kingdom other than an exhibition or show held or approved by the Society of Motor Manufacturers and Traders for the exhibition of motor goods by its Bond Signers. Any breach of this provision shall render the purchaser liable to indemnify the Company in respect of their liability to the Society aforesaid to pay such damages not exceeding £250, as the Committee of the Society aforesaid or its Council on appeal may award.

PAYMENT. Net cash on delivery.
The specifications and prices of the Cars in this catalogue are liable to alteration at any time.

DELIVERY. The prices quoted in the Company's catalogue are for delivery at the Company's Works at Cowley, in the County of Oxford in England, and are strictly net on the above-mentioned terms.

A delivery charge to be arrived at and calculated on the basis of fourpence per mile in the case of the Morris Eight model, and sixpence per mile in the case of all other models, for freightage from the Company's Works to the Depot of the Distributor or Dealer is authorised. Any time of delivery named in the Company's contracts or correspondence is absolutely contingent upon war, strikes, riots, lock-outs, trade disputes, accidents, fire, delay or failure of sub-contractors to complete their contracts, or any other unforeseen circumstances, and should delivery be delayed in consequence of any of the foregoing contingencies the Company shall not be responsible for any damages caused by such delay.

SPARE PARTS. The Company endeavours to keep in stock for immediate delivery a full series of all parts for its vehicles that are liable to wear or to damage by accident. When ordering spare parts the identification number of the parts should be quoted if possible (see separate Spare Parts List), but in every case the chassis and engine numbers of the Car, for which such parts are required, must be given. Full instructions concerning this matter will be found in the Spare Parts List issued by the Company.

The Company reserves the right at any time to alter as may be considered advantageous or necessary any part that may be returned.

GENERAL. Any person, firm or company which the Company styles its authorised Distributors or Dealers are not authorised to advertise, incur any debts, or to transact any business whatsoever on behalf of the Company. Nor are they authorised to give any warranty or to make any representation on behalf of the Company other than those contained in the Company's guarantee. The Company reserves the right to hand over orders placed direct with the Company to authorised Distributors or Dealers in the appropriate territories. The Company does not undertake the fitting of additional accessories of any kind, nor will it deviate from its standard specifications of Cars owing to such action interfering with the general work of its Factory. Should the Company cease to manufacture a Car of the type or model ordered (whether the estimated date of delivery has arrived or not) the Company shall be at liberty to return the deposit paid on the order of the purchaser and declare its contract to be at an end without any further liability.

All previous catalogues and terms of any previous guarantee are hereby cancelled.

October, 1938

MORRIS MOTORS LIMITED

VISCOUNT NUFFIELD Chairman

OLIVER BODEN, O.B.E. Vice-Chairman

COWLEY OXFORD ENGLAND

Telephone . . . OXFORD 7101

Telex . . . OXFORD TELEX 7194

Telegrams . . . "VOITURETTE," TELEX, OXFORD

Codes . . . BENTLEY'S, BENTLEY'S SECOND PHRASE, A.B.C. (5TH AND 6TH EDITIONS), WESTERN UNION AND PRIVATE





