

Land-Rover Station Wagons





Land-Rover 4-wheel drive 7-seat, 10-seat and 12-seat Station Wagons have gained distinction throughout the world on major construction sites, on pioneering expeditions and safaris, at airports, with national and international organisations—anywhere, in fact, where unrestricted transport of personnel and equipment is needed all the year round in all climates and conditions. Although outwardly similar to previous models, Station Wagons of today are stronger, more reliable, safer and more refined. They are highly-developed working machines.

Some of the illustrations in this catalogue show vehicles fitted with optional extras. For full details of the extras available, see separate publication.

1. 109" wheelbase 10-seater.
2. 88" wheelbase 7-seater.
3. 109" wheelbase 12-seater.





Below, far left. The front compartment of Long Station Wagons has seating for driver and two passengers. The driver's seat is adjustable fore and aft. Door casings are trimmed and padded and there is a trimmed lining for the roof panel.

Far left. In the 12-seater, there are three forward-facing centre seats. These are replaced in the 10-seater by a full-width bench seat.

Left. Centre seats of the 12-seater can be folded forward individually to permit side entry into the rear compartment. The bench seat of the 10-seater may be similarly folded.

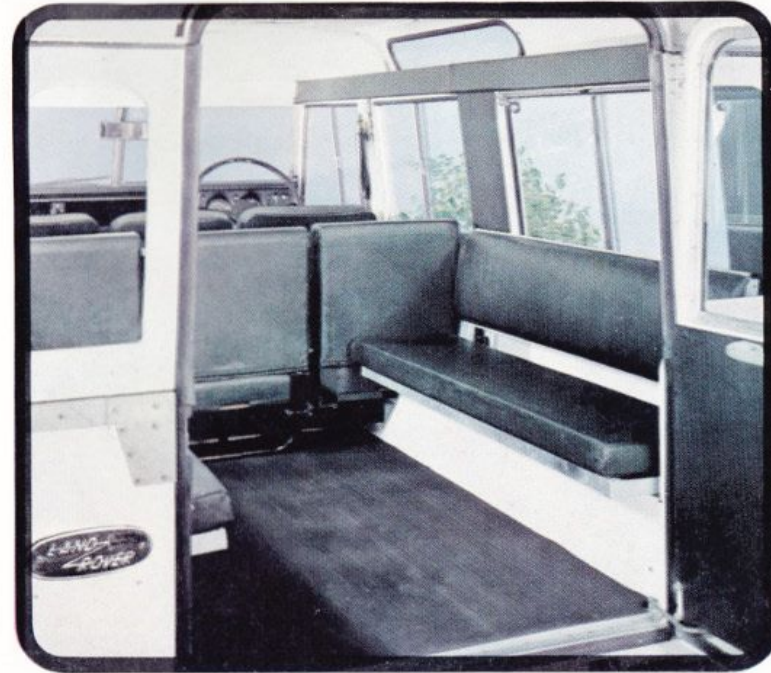

Left. Inward-facing seats are fitted at the rear of Long Station Wagons. They will accommodate four people in the 10-seater or six, in the 12-seater. On the 10-seater model, these seats may be folded up to provide more carrying space for equipment.



Three front seats are also provided in the 7-seat Station Wagon. Trimmed and padded door casings and a trimmed roof lining are fitted, as in Long models. At the rear are four inward facing seats. In the down position (*above, right*) they offer comfortable travelling accommodation for personnel in an interior that is light and well-ventilated. They can be folded up (*above, left*) when not required for passengers so that the whole floor area can be used for the carriage of goods and equipment.

Access to the rear compartment is gained through a side-opening door at the rear of

the vehicle. A folding mounting step is provided to assist entry.





Driving a Land-Rover Station Wagon can be a very satisfying experience. The comparatively high seating position affords an excellent view of the road or ground ahead. Instruments are grouped in a binnacle within the driver's line of vision together with ancillary controls. Direction indicators, horn, headlamp flasher and dip switch are all operated by a single finger-tip control on the steering column.

A highly-efficient fresh air heater is available as an optional extra and ventilation is taken care of by adjustable vents in the upper facia

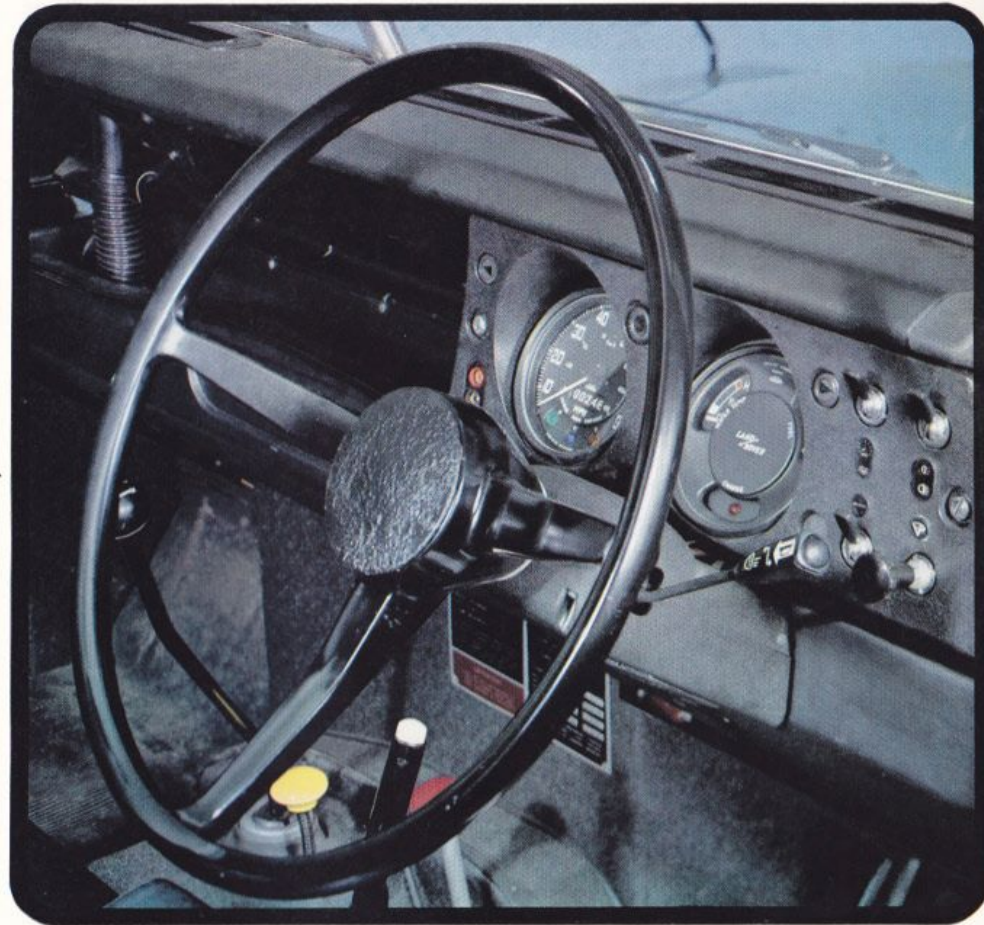

rail, sliding windows and ventilators in the roof. Improved door sealing inhibits the entry of dust and draughts. De Luxe seats (*above, left*) can be supplied as optional extras. They provide greater comfort and support and add a touch of luxury to the practical interior layout. All upholstery is in hard-wearing black P.V.C.

The inherent versatility of Land-Rover Station Wagons is considerably increased by the provision of power take-off facilities. The equipment can be supplied at extra cost and enables a wide range of installed, towed and standing machinery to be driven. Additionally, numerous items of optional equipment can be fitted, including special-purpose tyres. Special appliances are available through specialist manufacturers to supplement the vehicles' already exceptional work capability.

There are three basic power take-off positions – two of them on the transfer gearbox and the third at the front of the vehicle where a coupling can be made to the engine crankshaft.

The transfer gearbox drive units consist of a centre and a bottom take-off and both of these can be obtained as optional equipment. They form the basic drive for several variations of power take-off layout. For these applications the four main forward gears may be used to provide a wide range of speeds, but fourth gear should be used whenever possible. The intermediate gears can be used where lower speeds are required, but their use should be restricted to light loads, and duties of an intermittent nature.

When the vehicle is moving the centre and bottom drive units will operate at a speed which is in direct proportion to the road

speed of the vehicle. For stationary operation, the transfer gearbox is placed in neutral to disconnect the drive to the wheels and then the centre and bottom drive units can operate independently over a wide speed range.

An engine crankshaft drive can be used for a number of purposes, but apart from the capstan winch drive, which is supplied by the Company, all other installations are provided by specialist manufacturers for specific applications. Driving equipment from this point has the advantage that the power supply is not dependent on road speed gear selection and will be uninterrupted during combined stationary and mobile operation. Certain design limitations apply, however, and this drive position is restricted by space. It should be confined to units having a low rotary inertia, such as small fluid pumps.

The drive possibilities, utilising the Land-Rover power take-off system, are so extensive that almost any kind of application can be catered for. Some of the many examples are shown in the following pages. If you would like more information, please contact either your local distributor or dealer or, if necessary, the Land-Rover Special Projects Department or the Technical Sales Department of The Rover Company Limited.

Trailers

The Land-Rover Station Wagons, in common with all the other members of the Land-Rover range, are capable of towing a very wide range of trailers.



1 As camping vehicles the ten and twelve seater Station Wagons are probably unexcelled, particularly for those who want to explore out of the way places. A choice of specialist conversions is available.



4 Two-wheel cross-country tanker.

5 Four-wheel special purpose cargo trailer.

6 Four-wheel horse box.

7 Two-wheel general cargo trailer.

2 The Long Station Wagon, equipped as a cinema, is eminently suitable as a mobile class-room, particularly in underdeveloped countries. The electrical supply is provided by a power take-off driven generator.



3 The Land-Rover hydraulic winch is ideally suitable for self-recovery duties, hauling timber and equipment and for light hoisting operations.

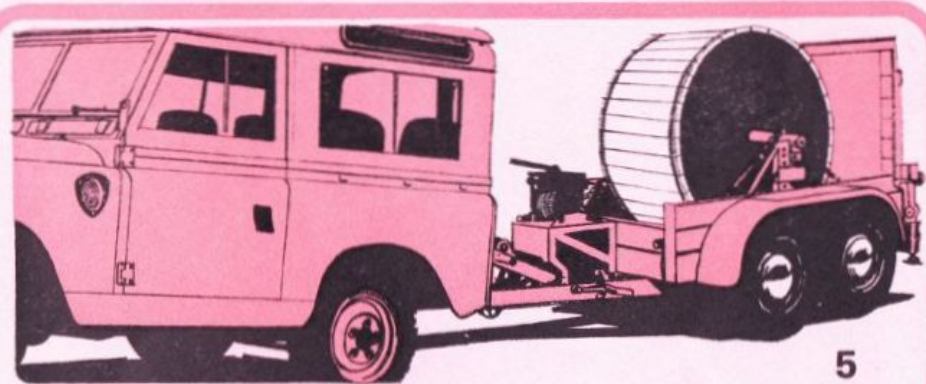

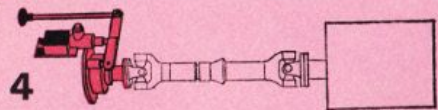

4

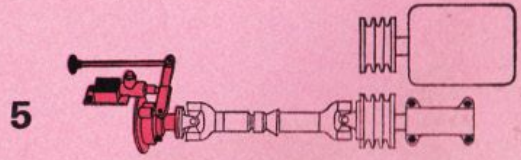

5

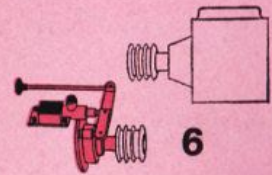

6

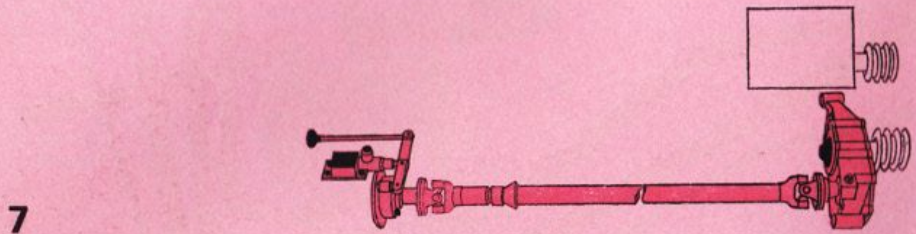

7

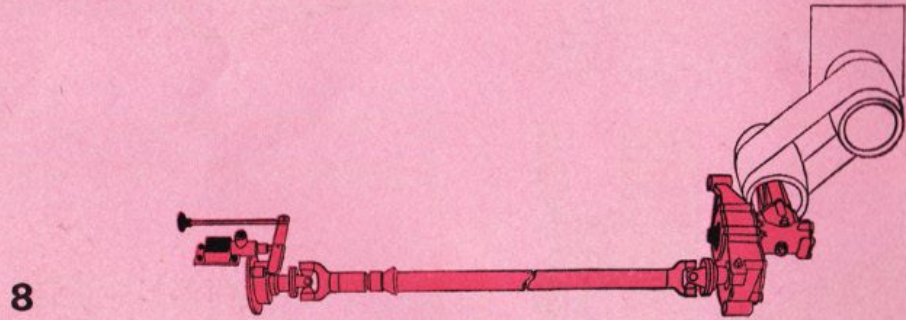

8

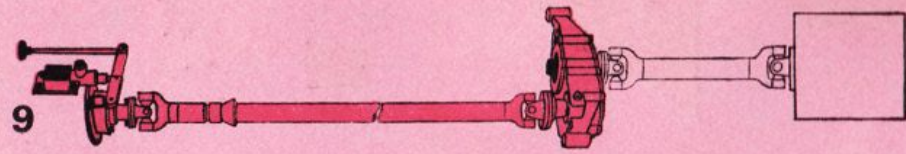

9

Mechanical Services

4 A drive can be taken from the centre power take-off to machinery mounted below the rear body floor.

5 A drive can also be taken from the centre power take-off to an outrigger bearing mounted in the chassis frame, and then by the belt to machinery mounted in the rear body section.

6 Centre power take-off equipped with V belt pulley will drive a machine mounted in place of the cab centre seat.

7 Rear power take-off equipped with a V belt pulley will drive a machine mounted in the rear body section.

8 The rear power take-off unit can be supplied complete with a flat belt drive unit for driving remote stationary equipment.

9 Rear power take-off driving a universal propeller shaft can be employed to operate trailer-mounted equipment, or remote stationary machinery.

Items 7, 8 and 9 cannot be fitted to the Long Station Wagons without special modifications.

Note The components shown in outline, without colour, are **not** supplied by The Rover Company Limited.

Power Take-off

1 The hydraulic winch is essentially a drum winch powered by a hydraulic pump and motor. The winch, which is complete with 100 ft. of steel cable, is mounted at the front end of the chassis and will exert a line pull of 4,000 lb. (1814 kg.).

2 Bottom power take-off is in effect an auxiliary gearbox secured to the base of the normal transfer gearbox. Both hydraulic and mechanical outputs can be connected to this unit.

3 A pulley, for a flat belt drive, can be fitted for use on certain rear power take-off applications. Suitable for the Regular Station Wagons only.

4 The centre power take-off drive unit is mounted on the rear of the transfer gearbox and forms the basis for most of the Land-Rover power take-off arrangements. Like the bottom power take-off it is available with hydraulic and mechanical outputs.

5 The rear power take-off is an auxiliary gearbox with a splined output shaft mounted on the rearmost chassis cross member. The drive for the rear power take-off is taken from the centre power take-off via a universally jointed propeller shaft. Suitable for the Regular Station Wagons only.

6 A capstan winch can be mounted on the front of the vehicle and driven from the engine crankshaft. The winch will provide a total line pull of 2,500 lb. (1134 kg.).

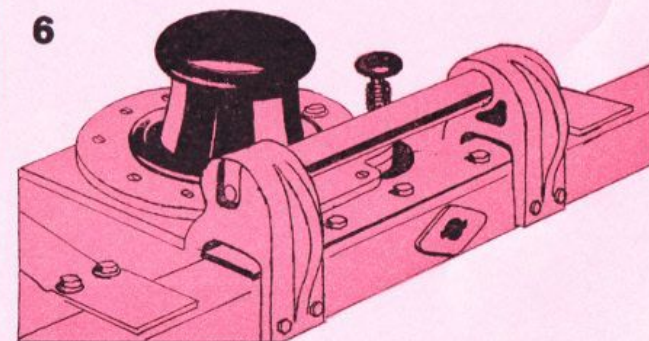
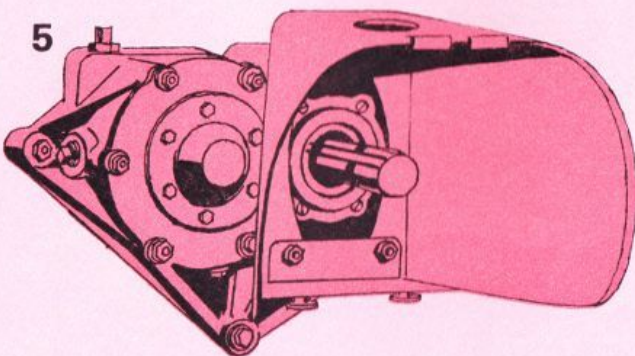
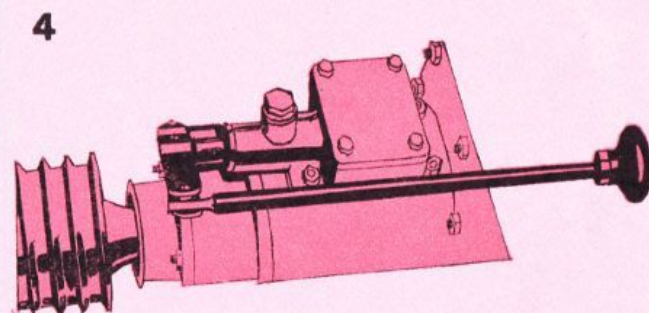
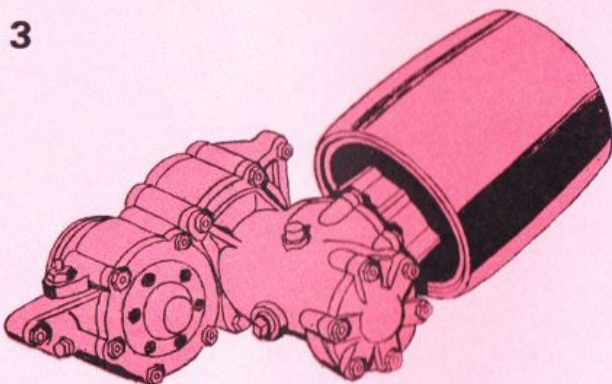
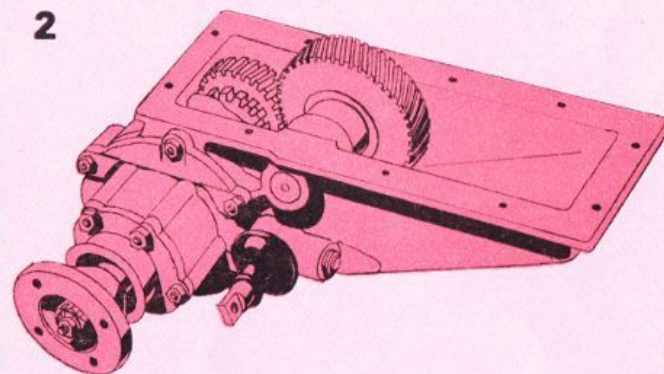
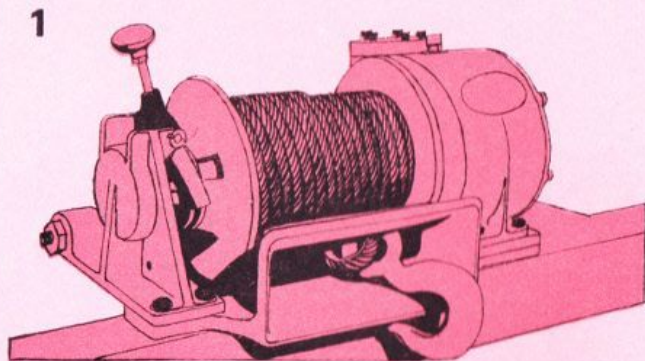

Power take-off facilities are restricted with the 2.6 litre Petrol Engine, and any proposed take-off application should be referred to the Land-Rover Special Projects Department for scrutiny.

Power Take-off Versatility

Hydraulic Services

1 The centre power take-off can be supplied complete with an integral hydraulic pump to provide the motive power for equipment such as winches.

2 The bottom power take-off can be supplied complete with an integral hydraulic pump.

3 Provision can be made to drive a variety of equipment, including hydraulic pumps, from the engine crankshaft.

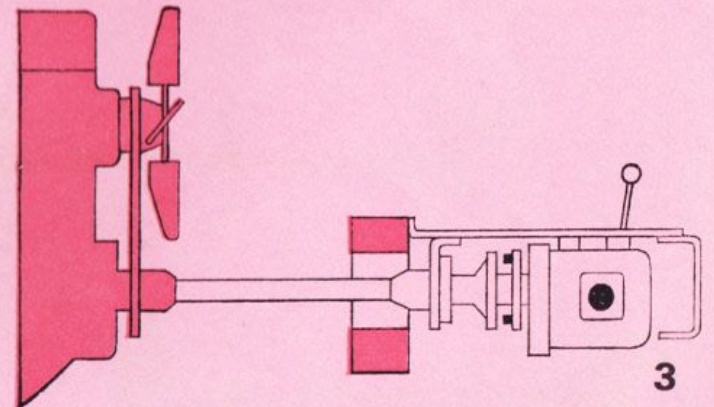
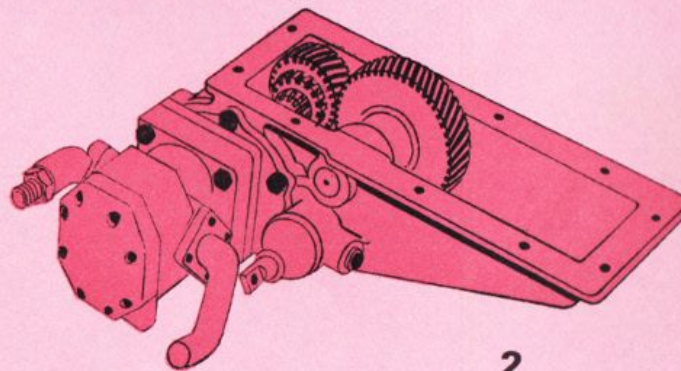
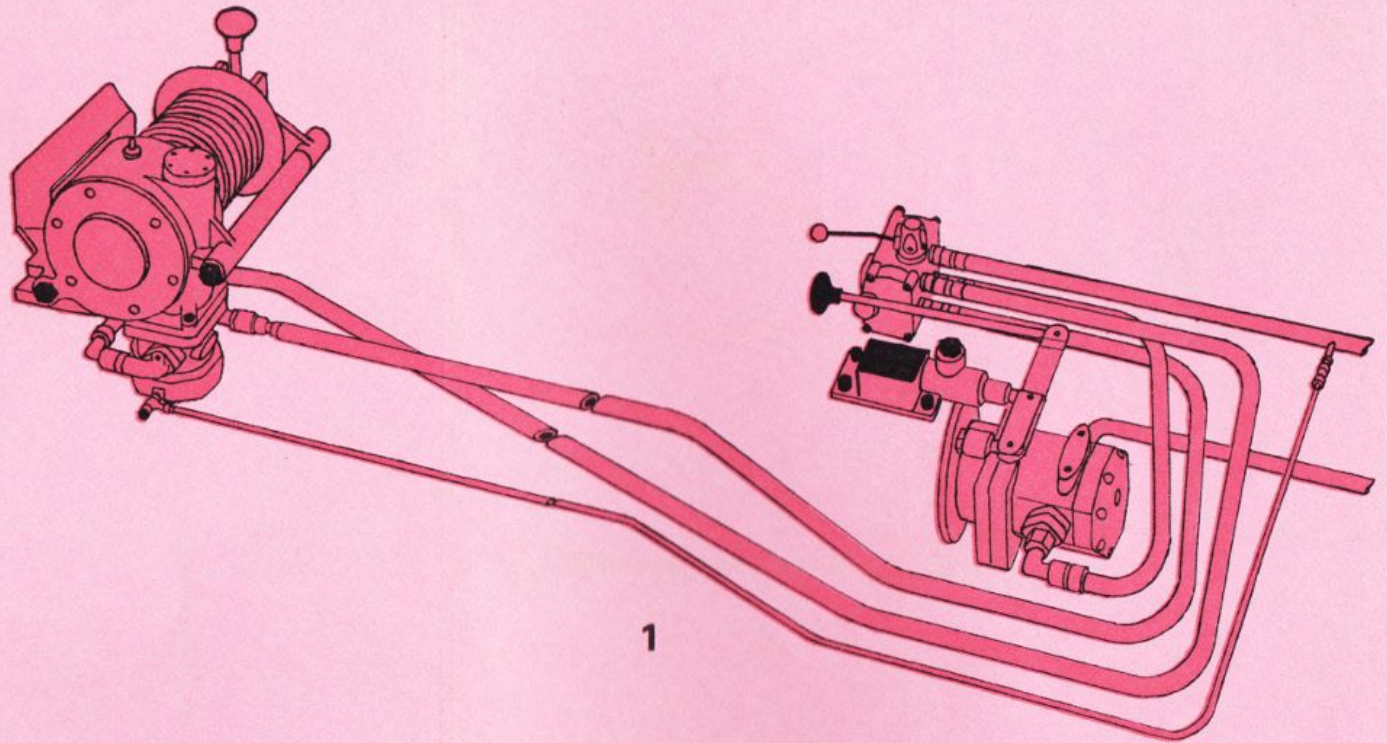

Optional Equipment

Station Wagons

●—denotes applicability
Std.—fitted as standard equipment

	7 seats		10 & 12 seats		
	Petrol	Diesel	2½ Petrol	2½ Diesel	2-6 Petrol
Alternator, Lucas 18 ACR	●	●	●	●	●
Ash tray	●	●	●	●	●
Auxiliary switch and instrument panels	●	●	●	●	●
Chaff guard (radiator)	●	●	●	●	●
Covers for universal joint	●	●	●	●	●
Engine speed governor	●	Std.	●	Std.	
Fire extinguisher (including fixing bracket and screws)	●	●	●	●	●
Fog lamp kit	●	●	●	●	●
Front axle with reinforced casing	●	●	●	●	●
Fuel tank (extra)	●		●		●
Hazard warning device	●	●	●	●	●
Heated windscreen conversion kit	●	●	●	●	●
Heater and demister (fresh air)	●	●	●	●	●
Heater, electric immersion, 200/250 volt, 250 watt	●	●	●	●	●
Heater, electric immersion, 100/125 volt, 250 watt	●	●	●	●	●
Heavy duty rear springs and front and rear shock absorbers	●	●	●	●	●
Lock, bonnet (de luxe)	●	●	●	●	●
Lock for spare wheel on bonnet (provision for)	●	●	●	●	●
Lock for fuel filler (provision for)	●	●	●	●	●
Mat, link, front	●	●	●	●	●
Mat, link, for floor of body	●	●	●	●	●
Mirrors, external	●	●	●	●	●
Mud flaps	●	●	●	●	●
Oil cooler unit	●	●	●	●	
Oil pressure gauge	●	●	●	●	●
Pads, rubber, for clutch and brake pedals	●	●	●	●	●
Plug (7-pin) and socket set, trailer towing	●	●	●	●	●
Power take-off, bottom, with mechanical drive	●	●	●	●	●
Power take-off, bottom, complete assembly, hydraulic pump	●	●	●	●	●
Power take-off, rear (splined shaft)	●	●	●	●	●
Power take-off, centre	●	●	●	●	●
Propeller shaft grommet set	●	●	●	●	●
Pump (foot)	●	●	●	●	●
Radio	●	●	●	●	●
Rear drive unit with pulley	●	●	●	●	●
Reinforced front axle	●	●	●	●	●
Roof rack	●	●	●	●	●

Spare wheel carrier on de luxe bonnet
Speedometer m.p.h. with trip
Split charge facility
Sun visors, interior and exterior
Suppressors, radio interference
Swivel pin housing gaiter set

Throttle control (hand)
Towing and lifting rings
Towing pintles
Towing hooks
Towing plates for equipment

Winch, capstan
Winch, hydraulic
Windscreen, laminated
Wire mesh guards for head, side, tail, stop and flasher lamps

Tyres

6-00×16 Dunlop T28 "Trakgrip" tyres and tubes
7-50×16 Dunlop Road Pattern tyres and tubes
7-50×16 Dunlop T29A "Trakgrip" tyres and tubes
7-50×16 Michelin "XY" tyres and tubes
8-20×15 Dunlop circumferential tread — sand
9-00×15 Dunlop block tread — sand
7-50×16 Michelin "XS" tyres and tubes
7-50×16 Dunlop RK3, Avon TM tyres and tubes
7-50×16 Dunlop RK3, Avon TM tyres and tubes — Standard Alternatives (109 in. wheelbase models).
6-00×16 Dunlop RK3, Avon TM tyres and tubes — Standard Alternatives (88 in. wheelbase models).

	7 seats		10 & 12 seats		
	Petrol	Diesel	2½ Petrol	2½ Diesel	2-6 Petrol
Spare wheel carrier on de luxe bonnet	●	●	●	●	●
Speedometer m.p.h. with trip	●	●	●	●	●
Split charge facility	●	●	●	●	●
Sun visors, interior and exterior	●	●	●	●	●
Suppressors, radio interference	●	●	●	●	●
Swivel pin housing gaiter set	●	●	●	●	●
Throttle control (hand)	●	Std.	●	Std.	●
Towing and lifting rings	●	●	●	●	●
Towing pintles	●	●	●	●	●
Towing hooks	●	●	●	●	●
Towing plates for equipment	●	●	●	●	●
Winch, capstan	●	●	●	●	●
Winch, hydraulic	●	●	●	●	●
Windscreen, laminated	●	●	●	●	●
Wire mesh guards for head, side, tail, stop and flasher lamps	●	●	●	●	●
6-00×16 Dunlop T28 "Trakgrip" tyres and tubes	●	●	●	●	●
7-50×16 Dunlop Road Pattern tyres and tubes	●	●	●	●	●
7-50×16 Dunlop T29A "Trakgrip" tyres and tubes	●	●	●	●	●
7-50×16 Michelin "XY" tyres and tubes	●	●	●	●	●
8-20×15 Dunlop circumferential tread — sand	●	●	●	●	●
9-00×15 Dunlop block tread — sand	●	●	●	●	●
7-50×16 Michelin "XS" tyres and tubes	●	●	●	●	●
7-50×16 Dunlop RK3, Avon TM tyres and tubes	●	●	●	●	●
7-50×16 Dunlop RK3, Avon TM tyres and tubes — Standard Alternatives (109 in. wheelbase models).	●	●	●	●	●
6-00×16 Dunlop RK3, Avon TM tyres and tubes — Standard Alternatives (88 in. wheelbase models).	●	●	●	●	●

Seven-seater Station Wagons are based on the 88" wheelbase Regular Chassis (*below, right*) and possess all the ruggedness and mobility of the basic all-purpose vehicle. Both ten-seater and twelve-seater Long Station Wagons employ the equally versatile 109" wheelbase (*far right*). The chassis are of immensely strong box-section construction, built to withstand the constant 'hammering' of cross-country operation. Being painted on the inside as well as outside the frames are resistant to rust and corrosion over very long periods of use.

Individual components are equally tough and the complete units combine good ground clearance with a low centre of gravity to minimise 'grounding' and give stability on steep slopes.

TRANSMISSION

Two- or four-wheel drive. Main gearbox has four forward speeds and one reverse, with synchromesh on all forward gears. An additional ratio is provided by the transfer box giving a total of eight forward and two reverse speeds. Front and rear axles are fully-floating and have spiral bevel drive.

CHASSIS FRAME

Welded steel box-section of great strength. Cross members give diagonal and torsional rigidity.

BRAKES

Hydraulic. Servo assistance provided on all Long Station Wagons.

ENGINES

4-cylinder petrol, 4-cylinder diesel or, on Long models, 6-cylinder petrol.

SUSPENSION

Underslung semi-elliptic springs controlled by double-acting hydraulic telescopic shock absorbers.

POWER TAKE-OFF

Provision for centre and rear power take-off drives. Capstan or hydraulic winch can be fitted at front (except on 6-cylinder models).

BODY

Steel fittings, including bulkhead and front grille surround, are either treated and painted or heavily galvanised.

All body panels are of non-corrodible light alloy.

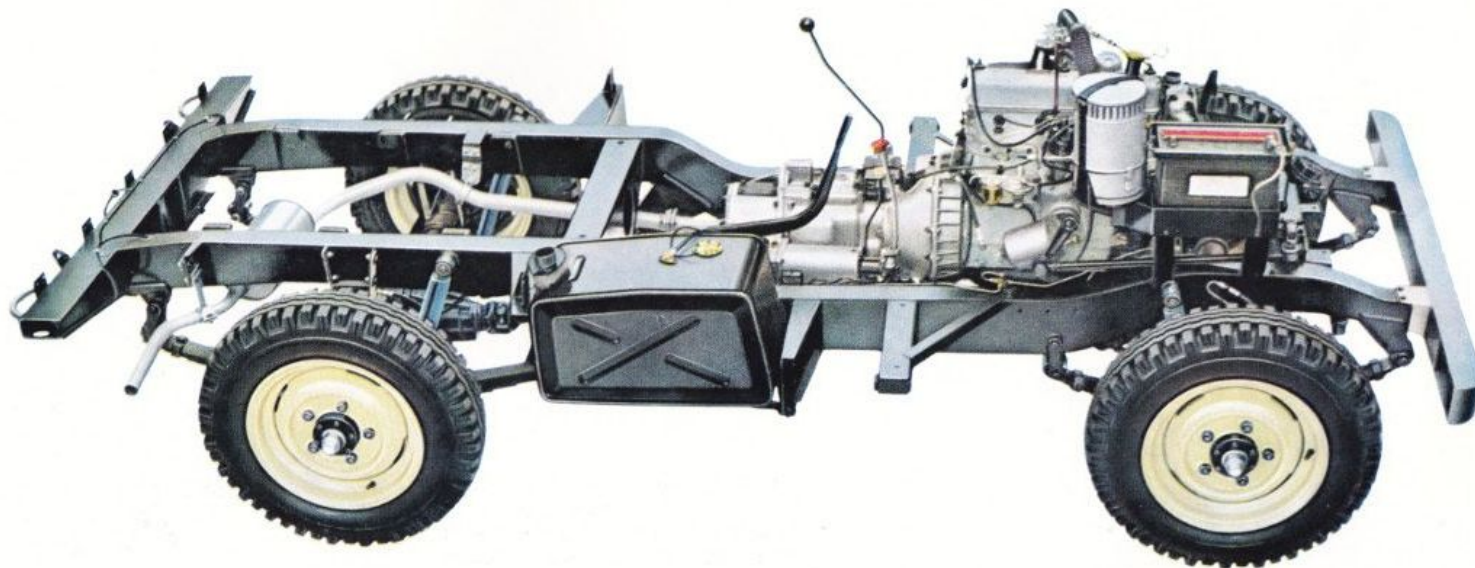
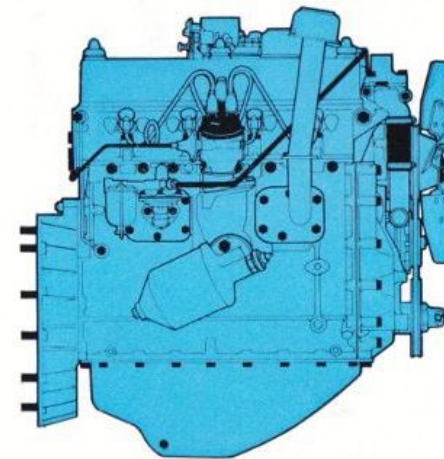

4-CYLINDER PETROL ENGINE

(Extreme left)

Offered on Regular and Long Station Wagons. It provides ample power for all normal vehicle uses.

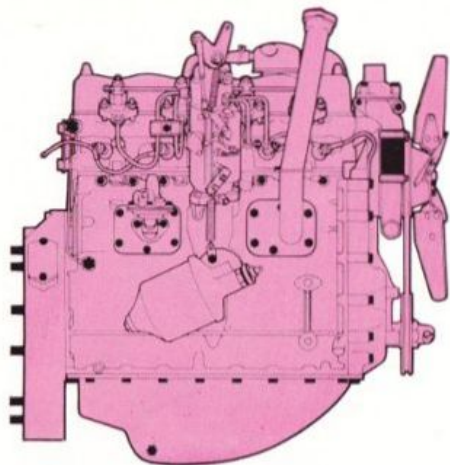

4-CYLINDER DIESEL ENGINE *(Left)*

Diesel power is also available and adds further to the efficiency and economy of the Land-Rover in conditions which favour the use of this type of engine.

6-CYLINDER PETROL ENGINE *(Right)*

A 2.6-litre, six-cylinder petrol engine is offered as an additional alternative on Long Station Wagons. It provides higher performance and greater speed for frequent road use.

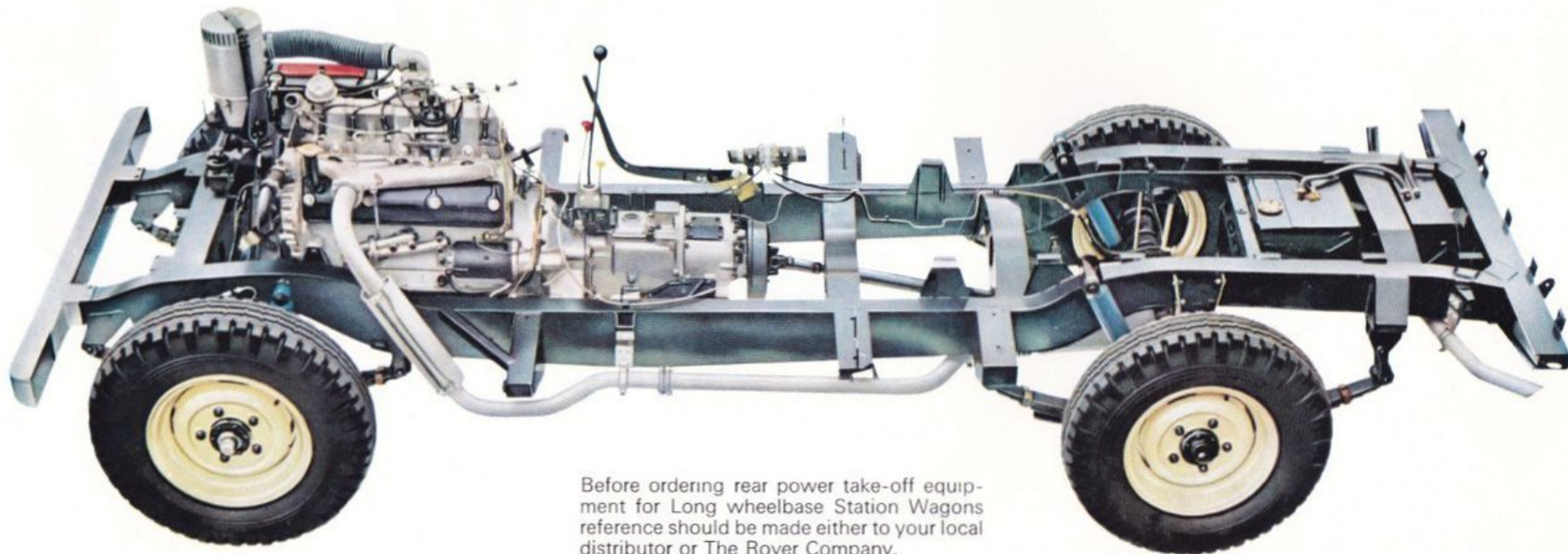
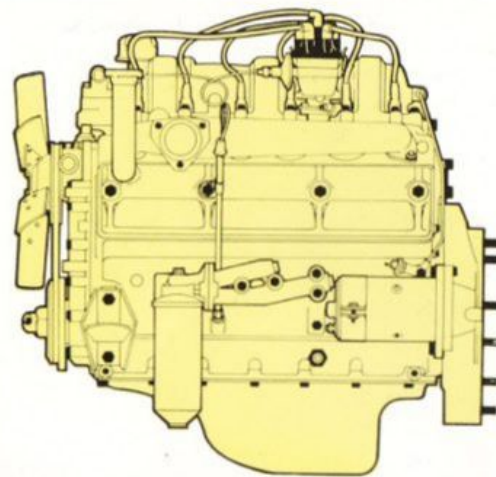

Before ordering rear power take-off equipment for Long wheelbase Station Wagons reference should be made either to your local distributor or The Rover Company.

SPECIFICATION

ENGINES

4-CYLINDER PETROL

No. of cylinders	.. 4.
Bore	.. 3.562" (90.47 mm.).
Stroke	.. 3.5" (88.9 mm.).
Capacity	.. 2,286 c.c. (139.5 cu. in.).
Valve position	.. Overhead.
Compression ratio	.. 8 : 1.
B.H.P. (DIN)	.. 70.5 at 4,000 rev./min.
Torque (DIN)	.. 16.5 Mkg. (120 lb. ft.) at 1,500 rev./min.

LUBRICATION SYSTEM

Type	.. Pressurised by submerged gear type pump.
Filters	.. Pump intake gauze filter in sump and external full flow filter.
Sump capacity	.. 11 pints (13 U.S. pints; 6.25 litres).

COOLING SYSTEM

Type	.. Pressurised with pump fan and thermostat.
Capacity	.. 14½ pints (8.10 litres; 17.1 U.S. pints).

FUEL SYSTEM

Carburettor	.. Zenith down-draught type 36 I.V.
Filters	.. Tank, paper element.
Air cleaner	.. Oil bath with built-in centrifugal pre-cleaner.
Pump	.. Mechanical with sediment bowl and priming lever.

ELECTRICAL SYSTEM

Ignition	.. By coil and distributor.
Starter	.. Solenoid operated by combined ignition/starter switch key.

6-CYLINDER PETROL

(Long Station Wagons only)

No. of cylinders	.. 6.
Bore	.. 3.063" (77.8 mm.).
Stroke	.. 3.625" (92.075 mm.).
Capacity	.. 2,625 c.c. (160.3 cu. ins.).
Valve position	.. Overhead inlet, inclined side exhaust.
Compression ratio	.. 7.8 : 1 (7.0 : 1 optional).
B.H.P. (DIN)	.. 86 at 4,500 rev./min.
Torque (DIN)	.. 18.2 Mkg. (132 lb. ft.) at 1,750 rev./min.

LUBRICATION SYSTEM

Type	.. Pressurised by submerged gear type pump.
------	---

Filters Pump intake gauze filter in sump and external full flow filter.
Sump capacity	.. 12 pints (14.5 U.S. pints—7 litres).

COOLING SYSTEM

Type Semi-sealed and pressurised with pump, fan and thermostat.
Capacity 20 pints (24 U.S. pints—11.4 litres).

FUEL SYSTEM

Carburettor	.. Zenith 175—CD2S.
Filters	.. Tank, sediment bowl and fuel pump.
Air cleaner	.. Oil bath with built-in centrifugal pre-cleaner.
Pump	.. Electric, dual inlet type, located inside right-hand frame side member.

ELECTRICAL SYSTEM

Ignition	.. By coil and distributor.
Starter	.. Solenoid operated by combined ignition starter switch key.

4-CYLINDER DIESEL

No. of cylinders	.. 4.
Bore	.. 3.562" (90.47 mm.).
Stroke	.. 3.5" (88.9 mm.).
Capacity	.. 2,286 c.c. (139.5 cu. in.).
Valve position	.. Overhead.
Compression ratio	.. 23 : 1.
B.H.P. (DIN)	.. 62 at 4,000 rev./min.
Torque (DIN)	.. 14.2 Mkg. (103 lb. ft.) at 1,800 rev./min.

LUBRICATION SYSTEM

Type	.. Pressurised by submerged gear type pump.
Filters	.. Pump intake gauze-filter in sump, and external full flow filter.
Sump capacity	.. 11 pints (13 U.S. pints; 6.25 litres).

COOLING SYSTEM

Type	.. Pressurised, with pump, fan and thermostat.
Capacity	.. 13¾ pints (16.5 U.S. pints; 7.8 litres).

FUEL SYSTEM

Injector pump	.. C.A.V., D.P.A. distributor type, self-governing.
Injector type	.. C.A.V. Pintaux.
Filters	.. Sediment bowl on mechanical fuel pump, paper type filter, fuel tank.
Air cleaner	.. Oil bath with built in centrifugal pre-cleaner.
Pump	.. Mechanical with hand primer (high pressure type).

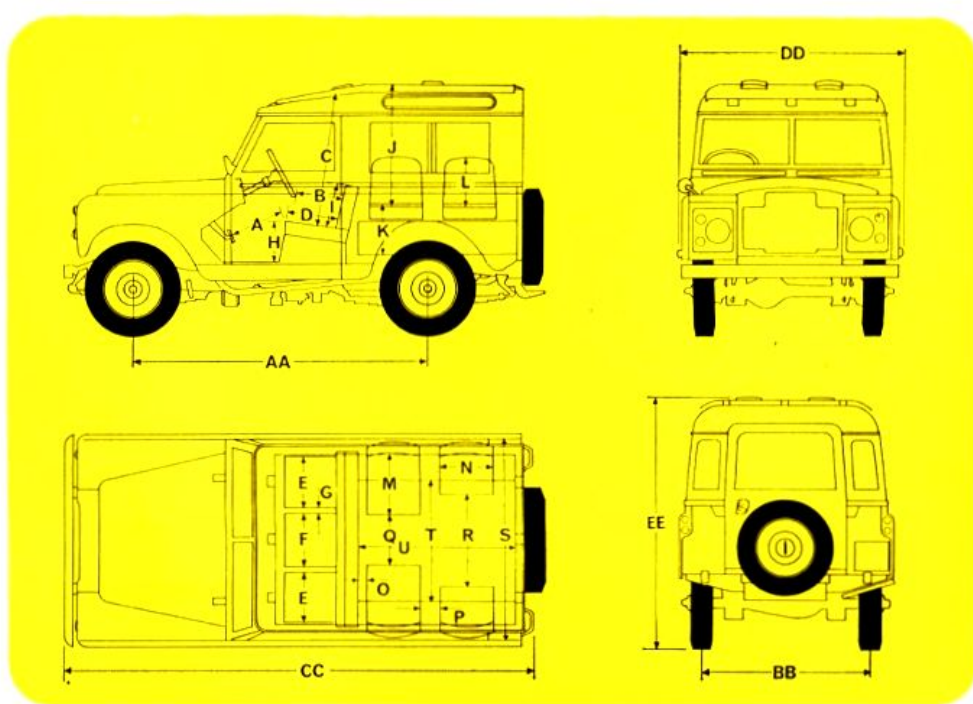

ELECTRICAL SYSTEM

Starter	.. Key switch and solenoid.
Heater plugs	.. Coil element 1.7 volts 36/42 amps. Operation—Combined with starter switch key.

TRANSMISSION

CLUTCH	
Type	.. Single dry plate, 9½" (241 mm.) dia. Diaphragm spring type.
Operation	.. Hydraulic.

MAIN GEARBOX

Type	.. Single helical constant mesh with synchronesh on all forward gears.
Oil capacity	.. 2½ pints (3 U.S. pints; 1.5 litres).

TRANSFER GEARBOX

Type	.. Two-speed reduction on main gearbox output.
Four wheel drive	.. Two/four wheel drive control on transfer box output.
Oil capacity	.. 4½ pints (5½ U.S. pints; 2.5 litres).

PROPELLER SHAFTS

Type	.. Open, to front and rear axles.
------	-----------------------------------

REAR AXLE

Type	.. Spiral bevel; floating shafts.
Ratio	.. 4.7 : 1.
Oil capacity	.. 3 pints (3½ U.S. pints; 1.7 litres).

FRONT AXLE

Type	.. Spiral bevel; floating shafts.
Ratio	.. 4.7 : 1.
Oil capacity	.. Differential, 3 pints (3½ U.S. pints; 1.7 litres). Universal joint housing, 1 pint (1¼ U.S. pints; 0.57 litres).

OVERALL RATIOS (Final Drive)

	High Transfer	Low Transfer
Top	5.4 : 1	11.1 : 1
Third	8.05 : 1	16.5 : 1
Second	12.0 : 1	24.6 : 1
First	19.88 : 1	40.70 : 1
Reverse	21.66 : 1	44.30 : 1

DIMENSIONS

7- SEATER STATION WAGON

		Ins.	Metres
AA	Wheelbase	88	2.23
BB	Track	51.5	1.308
CC	Overall length	142.5	3.62
DD	Overall width (over hinges)	66	1.68
EE	Overall height	76.5	1.94
—	Ground clearance	7.00	0.178
A	Front cushion to accelerator pedal	17.25	.438
B	Front squab to steering wheel	14.5	.368
C	Headroom, front seat	39	.99
D	Front to rear of front cushion	16.5	.42
E	Width of front cushion	18	.457
F	Width of front centre cushion	15	.381
G	Width between front seats	1	.025
H	Top of front cushion to floor	14.5	.368
I	Front squab height	18	.457
J	Headroom, rear seat	35	.890
K	Top of rear cushion to floor	14.5	.368
L	Rear squab height	18	.457
M	Front to rear of rear cushion	18	.457
N	Width of rear cushion	16	.406
O	Width between front squab and rear cushion	5	.127
P	Width between rear cushions	3	.076
Q	Width across body between rear cushions (seats down)	14	.357
R	Width across body between rear cushions (seats up)	38	.965
S	Interior width of body at rear seats	56.25	1.429
T	Interior width of body between rear, seat boxes	36.3	.922
U	Interior length of body between front squabs and rear door	43	1.09

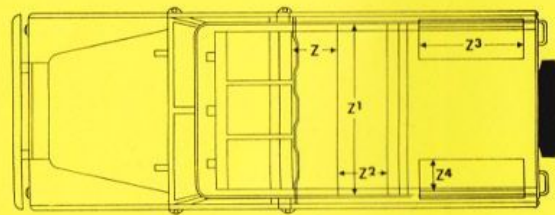
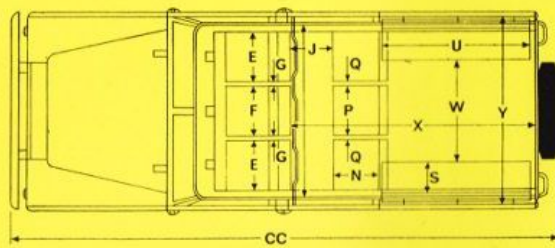
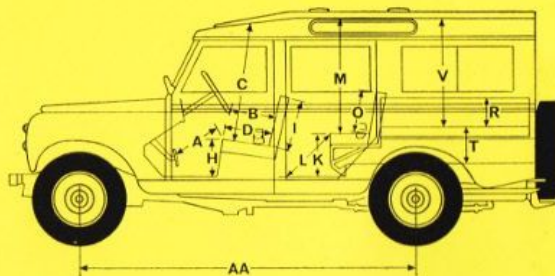

POWER TAKE-OFF POINTS

Central, bottom and rear power take-off drives available as optional extras.

CHASSIS DETAILS

FRAME

Type Welded fabricated box section side and cross members, black enamel dipped.

Front bumper Channel section, galvanised.

SUSPENSION

Road springs Semi-elliptic, underslung.

Shock absorbers Hydraulic double acting telescopic.

STEERING

Type Recirculating ball, worm and nut.

Steering wheel diameter 17" (43.18 cm).

Turning circle 88" (with 6 00" x 16" tyres)—38 ft (11.6 m) 109" (with 750" x 16" tyres) 47 ft. (14.3 m) diameter.
Number of turns lock to lock—3½.

BRAKES

Foot brake 2½ L. 4 cyl. models Hydraulic drum brakes 88"—leading and trailing shoes 1½" wide. 109"—Two leading shoes on front, leading and trailing shoes on rear. 2½" wide, servo assisted.

2-6 L. 6 cyl. models. Hydraulic drum brakes. 11" dia, servo assisted.

Front: Two leading shoes 3" wide.

Rear: Leading and trailing shoes, 2½" wide.

Hand brake Mechanical internal expanding drum brake on transfer box output.

WHEELS AND TYRES

Wheel type Ventilated disc.

Wheel size 88"—5 00" F x 16", 109"—5 50" F x 16".

Standard tyre and tube size 88"—6 00" x 16. 109"—7 50" x 16

Standard tread Dual-purpose (road and cross-country).

FUEL SYSTEM

Fuel tank Carried outside side member under right-hand seat on 88" and between side members behind rear axle on 109". Fitted with protective underplate and telescopic external filler tube.

DIMENSIONS

10- AND 12-SEATER STATION WAGONS

		Ins.	Metres
AA	Wheelbase	109	2.768
BB	Track	52.5	1.33
CC	Overall length	175.00	4.441
DD	Overall width (over hinges)	66.00	1.676
EE	Overall height	79.0	2.01
—	Ground clearance	8.25	0.209
A	Front cushion to accelerator pedal	17.25	.438
B	Front squab to steering wheel	14.5	.368
C	Headroom, front seat	39.00	.991
D	Front to rear of front cushion	16.00	.406
E	Width of front cushion	18.00	.457
F	Width of front centre cushion	15.00	.381
G	Width between front seats	1.00	.025
H	Top of front cushion to floor	14.5	.368
I	Front squab height	17.00	.431
J	Front squab to centre cushion	12.5	.318
K	Top of centre cushion to floor	14.5	.368
L	Centre cushion to front seat box	18.75	.476
M	Headroom, centre seat	37.5	.952
N	Front to rear of centre cushion	14.5	.368
O	Centre squab height	15.00	.381
P	Centre cushion width	15.50	.393
Q	Width between centre cushions	1.00	.025
R	Rear squab height	12.5	.317
S	Front to rear of rear cushion	13.00	.330
T	Top of rear cushion to floor	12.25	.311
U	Length of rear cushion minimum	48.00	1.219
V	Headroom, rear seat	34.5	.876
W	Width between rear seats	28.75	.730
X	Length of body between front squabs and rear door	80.00	2.032
Y	Interior width of body	56.875	1.44
Z	Front squab to centre cushion (10-str.)	16.00	.406
Z1	Centre cushion width (10-str.)	50.5	1.283
Z2	Front to rear centre cushion (10 str.)	14.5	.368
Z3	Length of rear cushion (10-str.)	32.25	.819
Z4	Front to rear of rear cushion (10-str.)	13.00	.330

Capacity 88"—10 gallons (12 U.S. gallons: 45 litres).
109"—16 gallons (19 U.S. gallons: 73 litres).

CHASSIS OPTIONAL EQUIPMENT

Includes Extra instruments, winches, towing equipment, special protective devices, and special purpose tyres. See separate publication for details.

ELECTRICAL EQUIPMENT AND INSTRUMENTATION

ELECTRICAL SYSTEM

Type Negative earth.
Voltage 12 volt.

ELECTRICAL EQUIPMENT

Battery Petrol—58 A.H. Diesel—95 A.H.
Alternator 16 A.C.R. 35 amps. output.
Windscreen wiper.. Dual arm.
Horn Windtone. Horn push on steering column stalk.

INSTRUMENTS AND CONTROLS

Speedometer .. Large diameter with total mileage recorder including oil pressure, headlamp main beam and cold start warning lights.

Water temperature and fuel gauges .. Combined in one large dial which also includes the charging warning light.

Panel light Illuminating speedometer, water temperature and fuel gauges. Switch operates when side and tail lamps are 'on'.

Petrol model .. Ignition switch. Operated by key. Toggle switch for head, side and tail lamps. Ignition warning light: red. Choke warning light: amber. Oil pressure warning light: green. Headlamp main beam warning light: blue.

Diesel model .. Lighting switch: toggle switch for head, side and tail lamps. Heater / starter / auxiliary switch: Operated by key. Engine stop control: located on dash. Charging warning light: red. Heater plug warning light: amber. Oil pressure warning light: green. Main beam warning light: blue. Fuel tank level warning light: blue. Engine speed hand control.

Lighting Headlamps — mounted in front wings.
Side-lamps and flasher lamps — mounted in front wings.
Tail lamps — twin units having double filament stop/tail bulbs and incorporating number plate illumination. Separate flasher lamps at rear.
Dip switch — operated by steering column control stalk.

BODY

CONSTRUCTION

All body panels are of non-corrosive light alloy, and all external steel fittings are heavily galvanised.

OPTIONAL EQUIPMENT

Includes fresh air heater, steering column lock (where legally required), hazard warning system and various interior equipment. See separate booklet for details.

COLOURS

Variations in body colours are possible for particular requirements in regard to fire appliances and special fleet customers specifications.

Quotations may be obtained from the factory on request.

Body Colour	Road Wheels	
Bronze green	Bronze green	Export only
Sand	Limestone	
Light green	Limestone	
Marine blue	Limestone	
Limestone	Limestone	
Mid grey	Limestone	
Mist coat white	Primer	

Trim	Colour	Home	Export
Interior trim and seats	Black	*	*
Interior trim and seats	Red	*	*
Roof interior lining	White	Fire Engines only	*

CONSTANTS WITH ALL COLOUR SCHEMES

Tropical roof Chassis frame	Limestone Black
-----------------------------	-----------------

PERFORMANCE

PAYLOADS

	88"	109"
Roadwork	7 persons plus 100 lb. (45 Kg.)	10 persons plus 400 lb. (181 Kg.)
Cross-country	6 persons plus 50 lb. (23 Kg.)	10 persons plus 200 lb. (91 Kg.)

WEIGHTS

	88"			109"		
	Front axle lb. Kg.	Rear axle lb. Kg.	Total lb. Kg.	Front axle lb. Kg.	Rear axle lb. Kg.	Total lb. Kg.
Petrol						
Unladen, plus 5 galls. fuel	1,724	1,557	3,281	1,739	2,013	3,752
	782	706	1,488	789	913	1,702
Max. allowable gross weight, normal road work ..	1,828	2,625	4,453	2,140	3,765	5,905
	830	1,190	2,020	970	1,710	2,680
Cross-country, standard road springs	1,828	2,425	4,253	2,140	3,565	5,705
	830	1,100	1,930	970	1,620	2,590
Diesel						
Unladen, plus 5 galls. fuel	1,814	1,611	3,425	1,846	2,076	3,922
	823	731	1,554	837	942	1,779
Max. allowable gross weight, normal road work ..	2,140	2,625	4,765	2,320	3,765	6,085
	971	1,190	2,161	1,052	1,708	2,760
Cross-country, standard road springs	2,140	2,425	4,565	2,320	3,565	5,885
	971	1,100	2,071	1,052	1,617	2,669

	88"		109"		109" 2-6 L. Petrol
	Petrol	Diesel	Petrol	Diesel	
Max. drawbar pull	4,000 lb. 1800 kg.	3,300 lb. 1497 kg.	3,500 lb. 1600 kg.	2,900 lb. 1315 kg.	3,890 lb. 1765 kg.
Max. gradient:					
Unladen	45°	45°	45°	45°	45°
Laden	37°	30°	39°	29°	41°



ROVER
BRITISH LEYLAND · UK LIMITED
SOLIHULL · WARWICKSHIRE · ENGLAND

Telephone: 021-743 4242

Telegrams: Rover, Solihull

The Rover — British Leyland UK Limited reserves the right to alter specifications, colour, designs or prices without notice and without incurring any obligation. While every effort is made in Rover literature, to provide information that is strictly up-to-date, no responsibility can be accepted for such alterations that occur after the date of going to press. Persons dealing in the Company's goods are not the agents of the Company and have no authority whatsoever to bind the Company by any expressed or implied undertaking. Sales are conditional upon terms of business, warranties, and service arrangements issued by The Rover — British Leyland UK Limited.