

**LAND
ROVER**

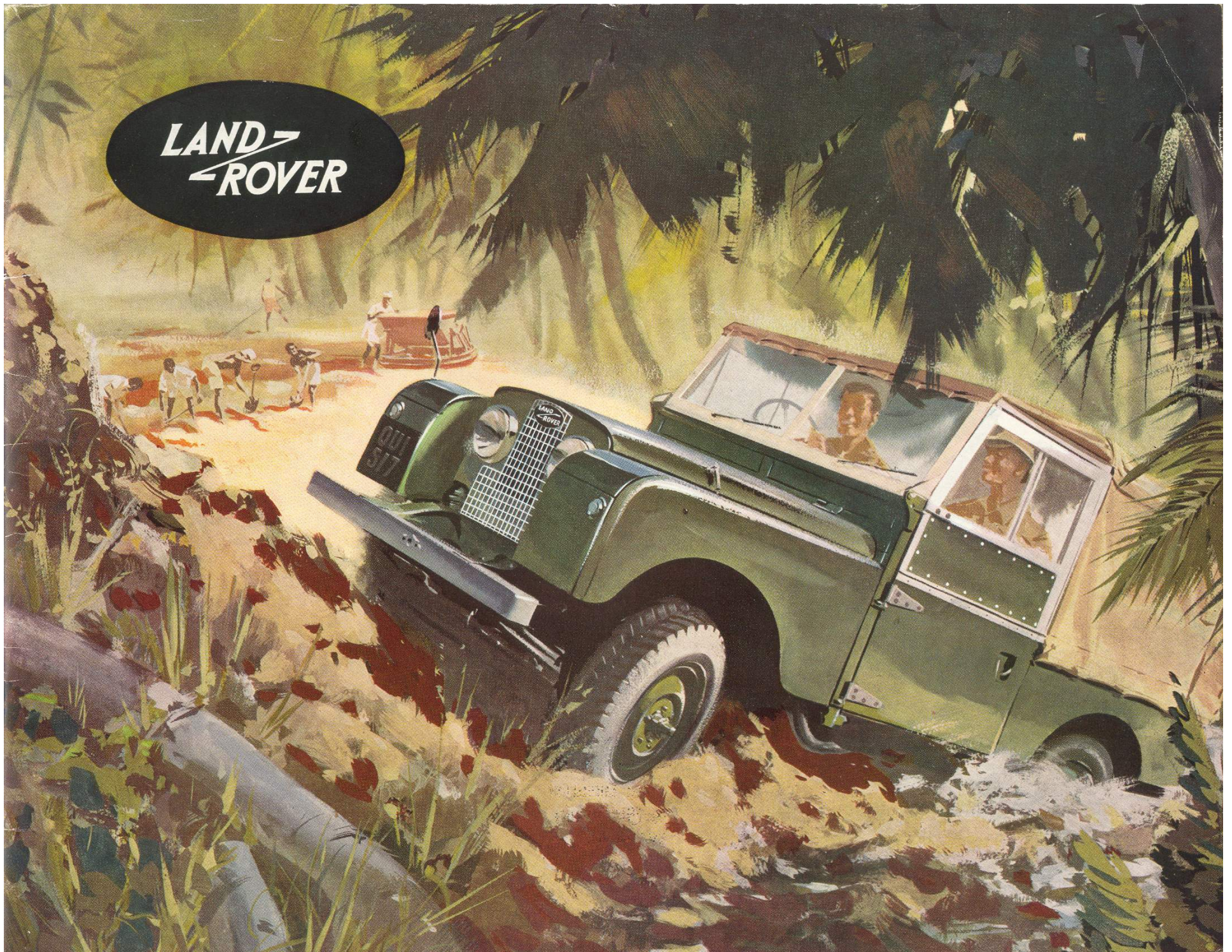



The colours of complete vehicles shown in this catalogue generally approximate to colours that can actually be supplied. Colours used for interior details and trim have been selected to pick out particular design features and do not necessarily indicate their availability.



1956 to June

THE 4 WHEEL DRIVE LAND-ROVER

For probable...and improbable jobs!

All round the world, anywhere on earth in fact, four-wheel drive Land-Rovers are doing work that no other vehicles can do. "Impossible" conditions have been overcome and "inaccessible" places reached by these ubiquitous machines whose unconquerable stamina and go-anywhere qualities have made them almost indispensable in many operational spheres.

From the equator to the arctic, high altitudes or low, in monsoon or drought, pulling, pushing, carrying or driving machinery, the amazing Land-Rover fills the bill in the same efficient and economical way. And its rugged construction, with incorrodible bodywork, ensures long trouble-free service.

There are five basic Land-Rover models, each having a range of optional extra equipment to meet every probable or improbable need.

86" WHEELBASE

**LAND-
ROVER**

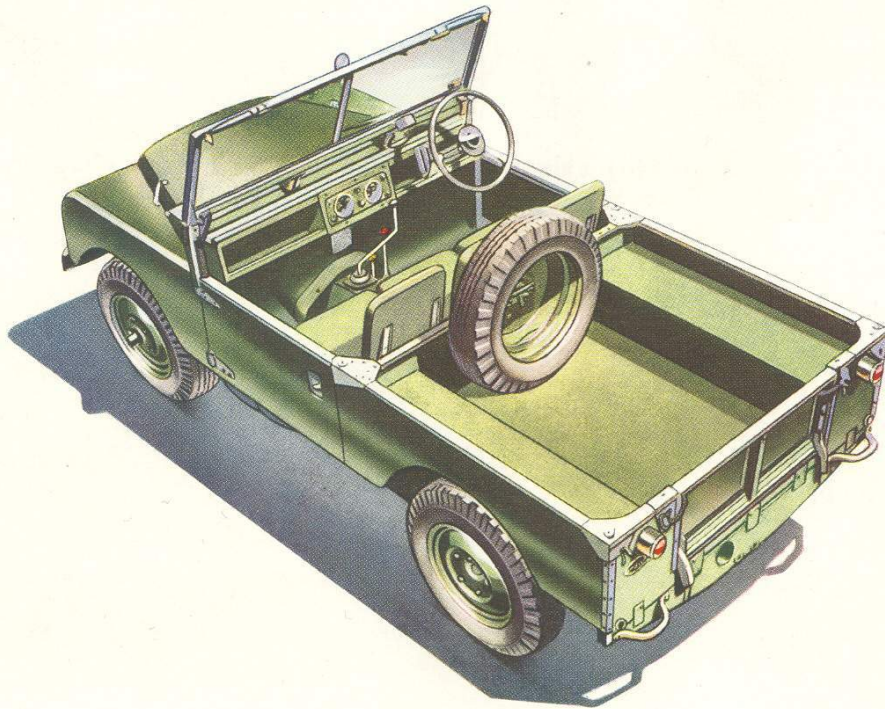

The 86 in. wheelbase, four-wheel drive Land-Rover is the general factotum of the range, providing the sort of go-anywhere transport that is needed on farms, ranches, estates and indeed in any situation where versatility and cross-country mobility are required. It can operate as a completely open vehicle or be fully enclosed by the weather-proof canvas hood. In either event the body provides excellent accommodation for three people and loads of up to 1,000 lb. (454 kg.).

All body panels are of non-rusting aluminium; steel portions, such as hinges, handles and reinforcements being galvanised to resist corrosion. The vehicle is thus not affected by weather or climate and can work indefinitely under the most appalling conditions.

To add to its almost unlimited field of operation, the Land-Rover is provided with centre and rear power take-off points enabling many varied types of machinery to be driven.

All in all the Land-Rover can justly claim to be the world's most versatile vehicle.

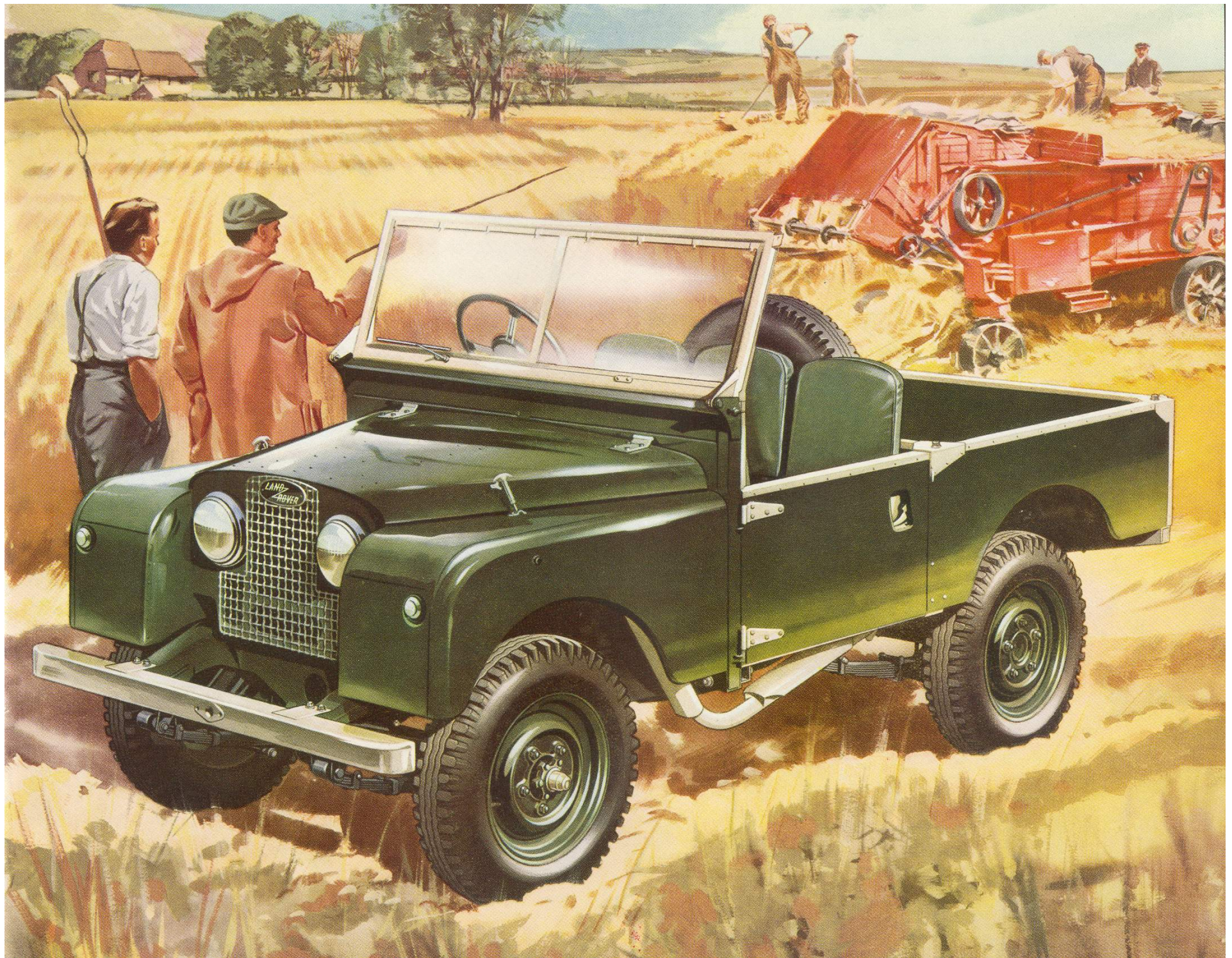

LAND- ROVER

86" WHEELBASE STATION WAGON

7 Seater version of the famous 4 wheel drive Land Rover

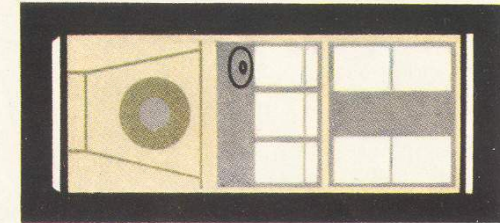
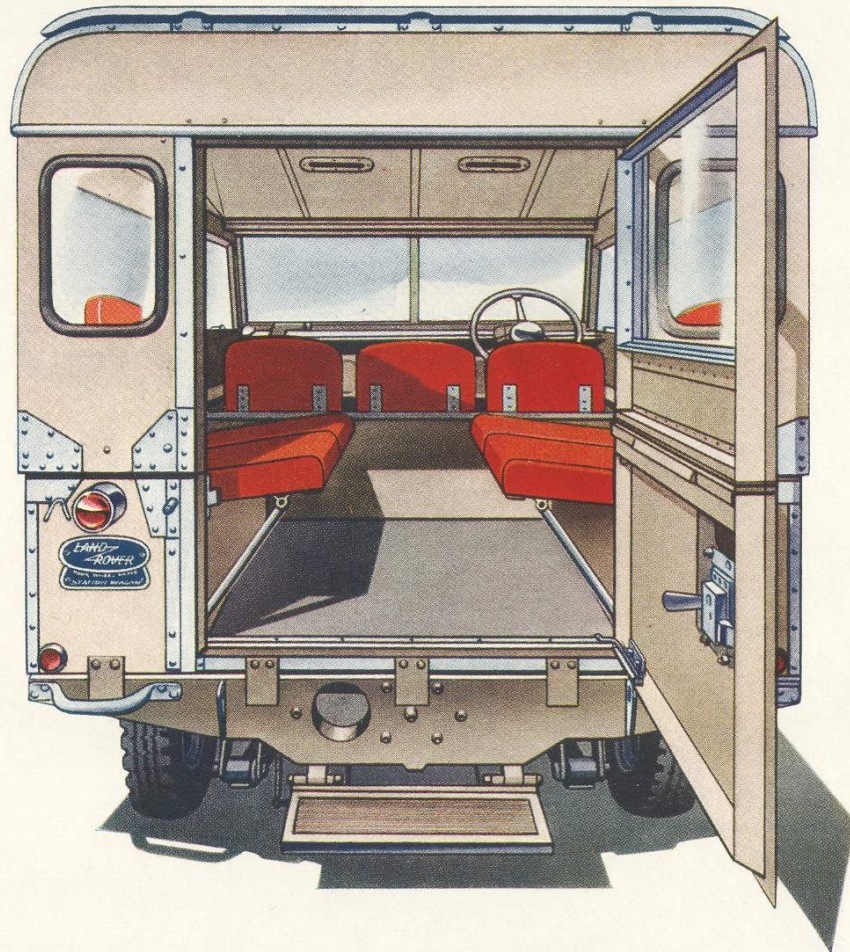

As an alternative passenger or goods carrier the Land-Rover 86 in. Station Wagon has great appeal in territories where tough conditions are likely to be met. It will, for instance, travel smoothly and comfortably on made-up roads, deal easily with untended tracks, or with four-wheel drive engaged, take to the rough with a facility achieved by no other make of vehicle.

As a passenger carrier the Station Wagon is a seven seater. Accommodation is provided in the front compartment for three people, while four fold-up seats are fitted in the body, these being easily accessible through a wide door at the rear. With the seats folded, excellent floor space is available for the transport of goods and equipment of every kind.

Toughly built and having a generous ground clearance, the Land-Rover 86 in. wheelbase Station Wagon is ever ready for day to day duty or high adventure in the inaccessible places of the world.

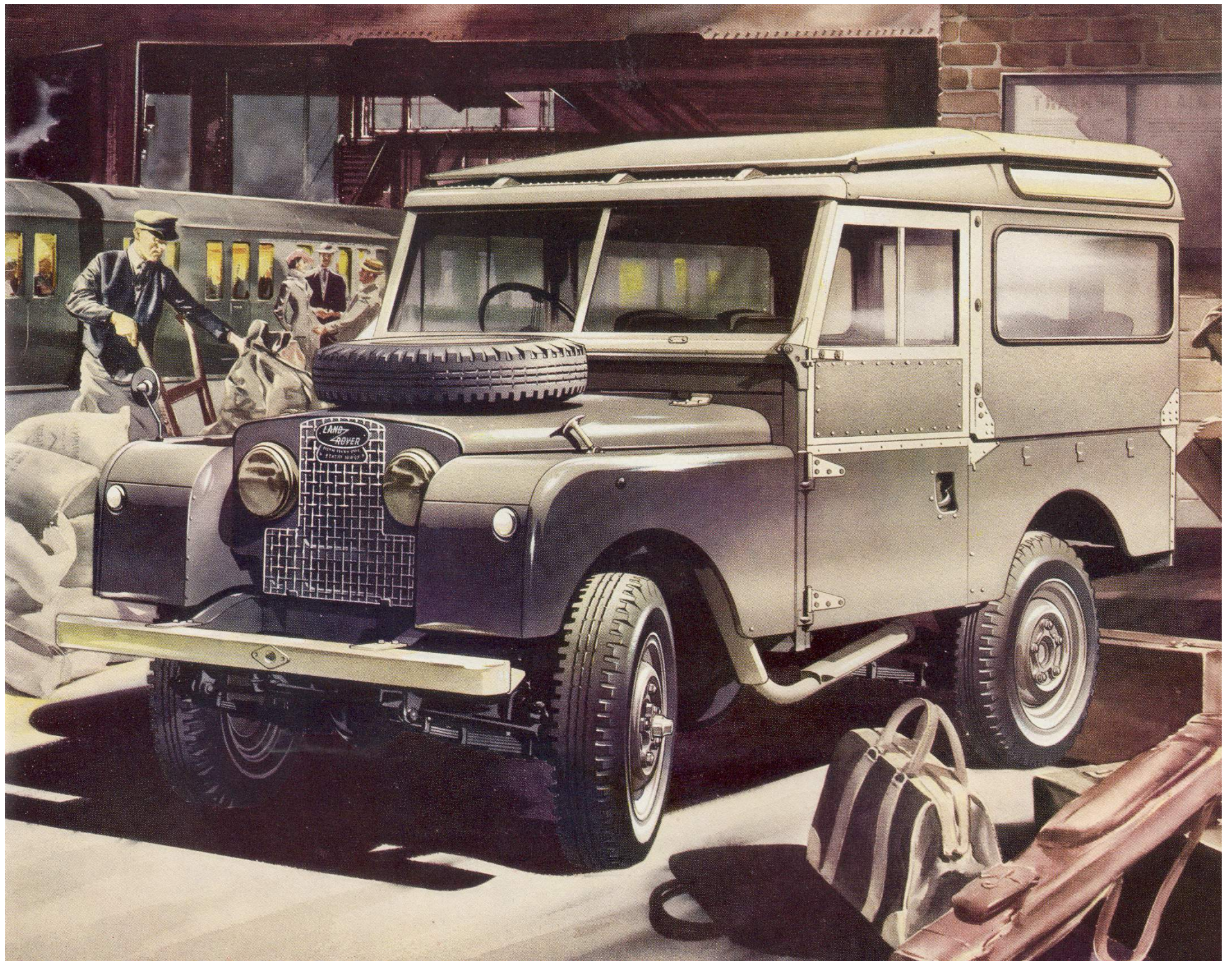

LAND- ROVER

107" WHEELBASE STATION WAGON

With ten-seater bodywork built on the long wheelbase chassis, the 107 in. Station Wagon is an important addition to the Land-Rover range.

The seating arrangement provides accommodation for three people in front, three on the back seat and four, facing inward, on additional seats fitted to the rear wheel boxes. If the wheel box seats are removed—a simple operation—and the back seat is folded right forward the whole body is available for load carrying, or alternatively, the back seat squab can be folded backward and the front seat cushions and squab redispensed to form a comfortable bed. Provision is made on the bonnet for carrying the spare wheel.

Like all Land-Rovers, the long wheelbase Station Wagon has four-wheel drive, and affords an ideal means of carrying personnel or equipment over difficult country. Its possibilities are numerous; oilfield, survey and safari duties providing exceptional scope for its outstanding versatility and powers of progress.

Wide doors give excellent access to the back seat which will comfortably accommodate three people.

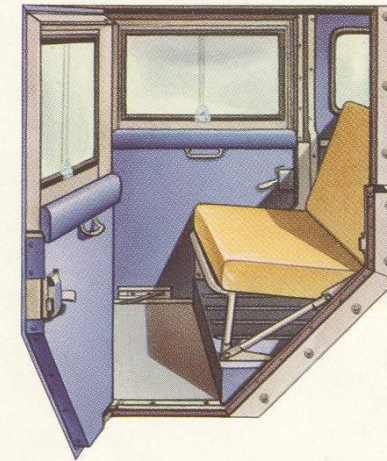

With the rear seat squab folded backward a bed can be made by redispensing the cushions and squab of the front seat.

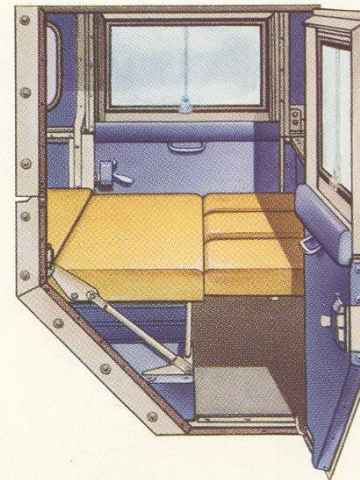

Additional seats mounted on the rear wheel boxes will carry four passengers, two on each side.

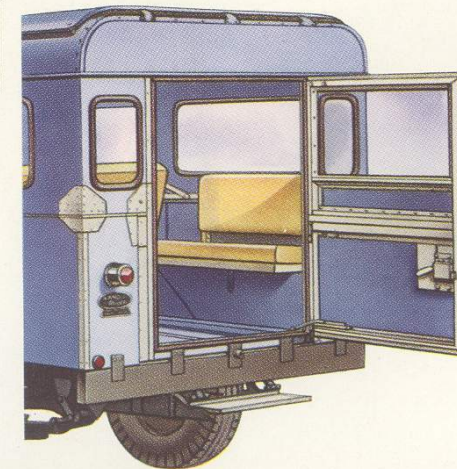





107" WHEELBASE

Another version of the four-wheel drive Land-Rover is the 107 in. wheelbase vehicle with all-purpose open body. The cab is fully enclosed and, if required, a weather-proof hood can be supplied at extra cost to protect the load space. As with its 86 in. wheelbase counterpart, the 107 in. is a model that has a great number of applications, its extra capacity making it a load carrier of exceptional merit.

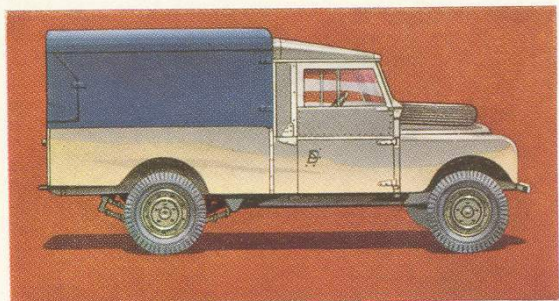

For difficult cross-country work loads of 1,200 lb. (544 kg.) can be carried in addition to the driver and two passengers, while on journeys using more normal road surfaces, payloads of 1,500 lb. (680 kg.) can be satisfactorily dealt with.

Two types of the 107 in. wheelbase Land-Rover are available: the standard model having a normally equipped cab, and the deluxe model with special interior upholstery and trim providing extra comfort for driver and passengers. A wide choice of other optional equipment is also available to ensure characteristic Land-Rover versatility.



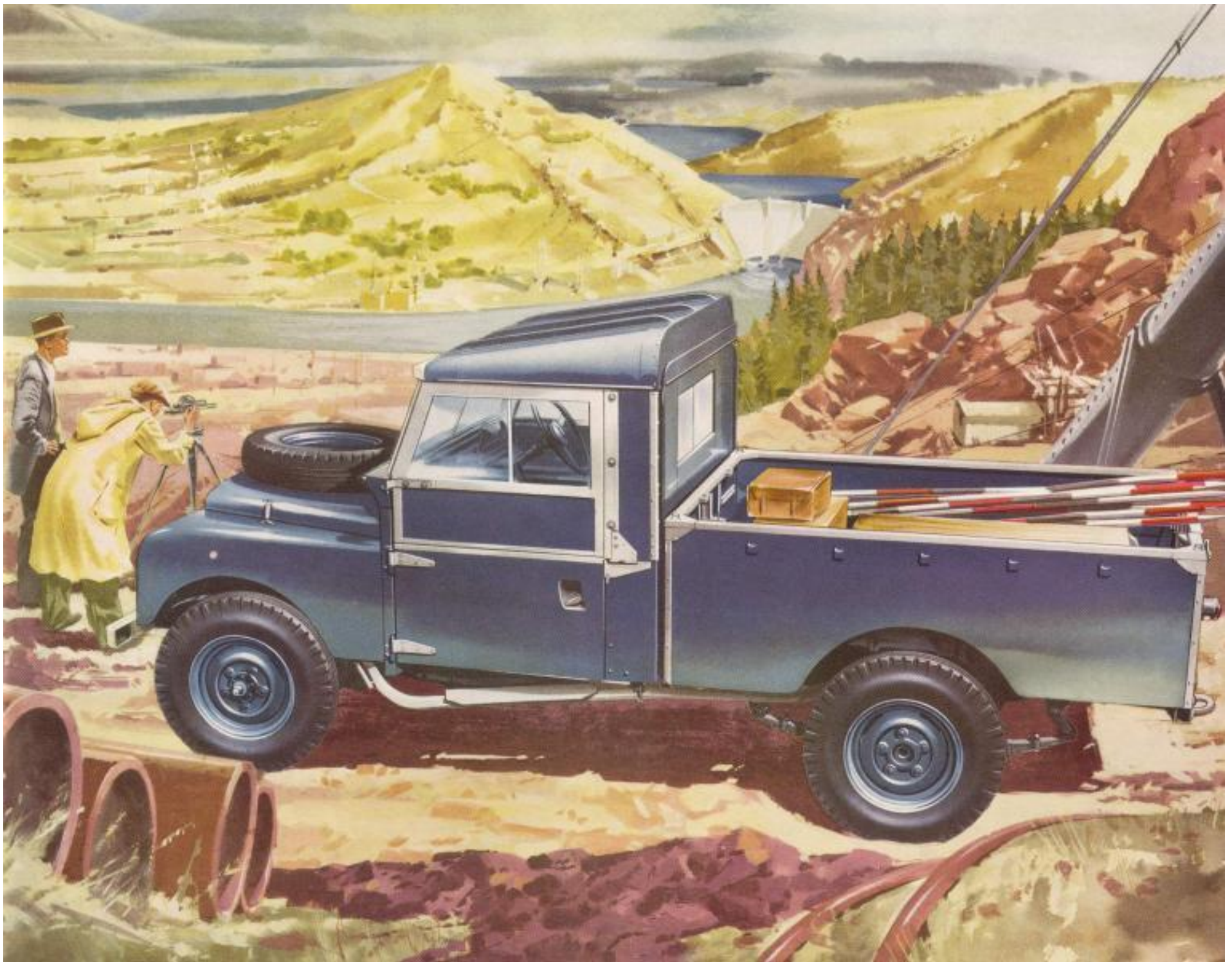



FIRE ENGINE

The Land-Rover Fire Engine is an exceptionally mobile self-contained appliance that can be employed with particular advantage in towns and villages with narrow streets, rural areas, factories, forestry reservations and similar locations where manoeuvrability and sturdiness are essential. Its modest size in conjunction with its two driving axles enables it to go virtually anywhere to reach outbreaks that cannot be approached by larger vehicles.

Standard equipment of the Land-Rover Fire Engine includes 40-gallon first aid water tank, 120 feet of rubber hose coiled on a drum, hose lockers and pump control panel. The pump itself has a rating of 210 gallons per minute at 100 lb. per sq. in. pressure for a 10 ft. lift.

A variety of optional extra equipment can be supplied by arrangement.

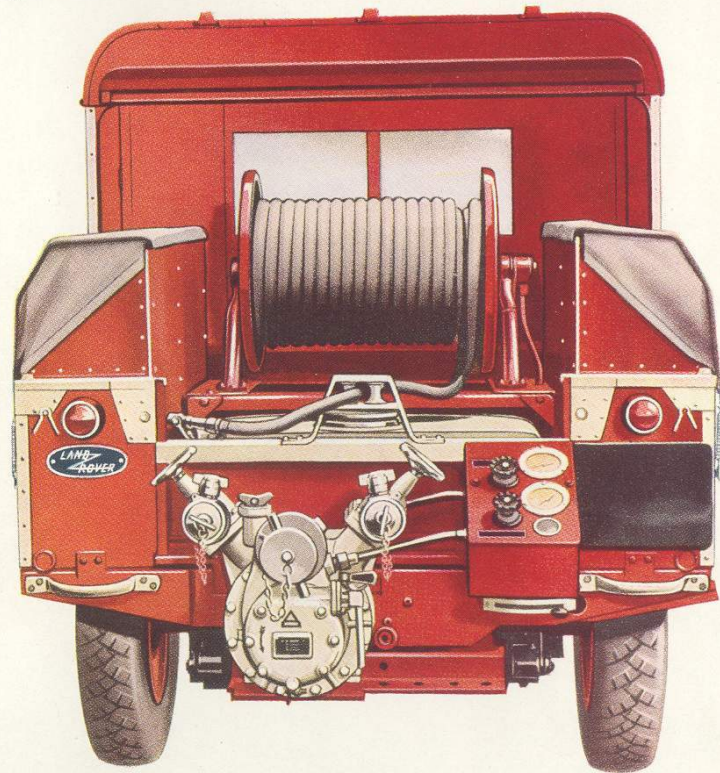
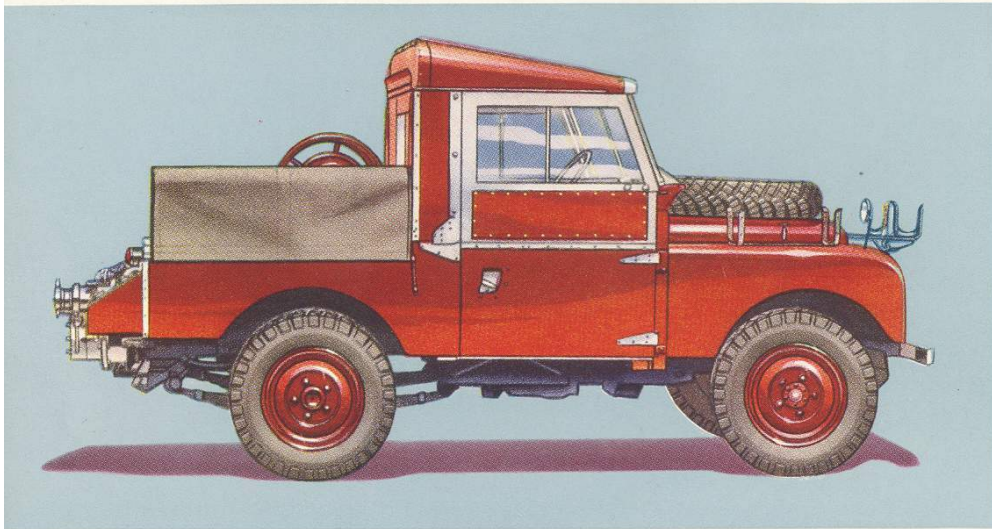

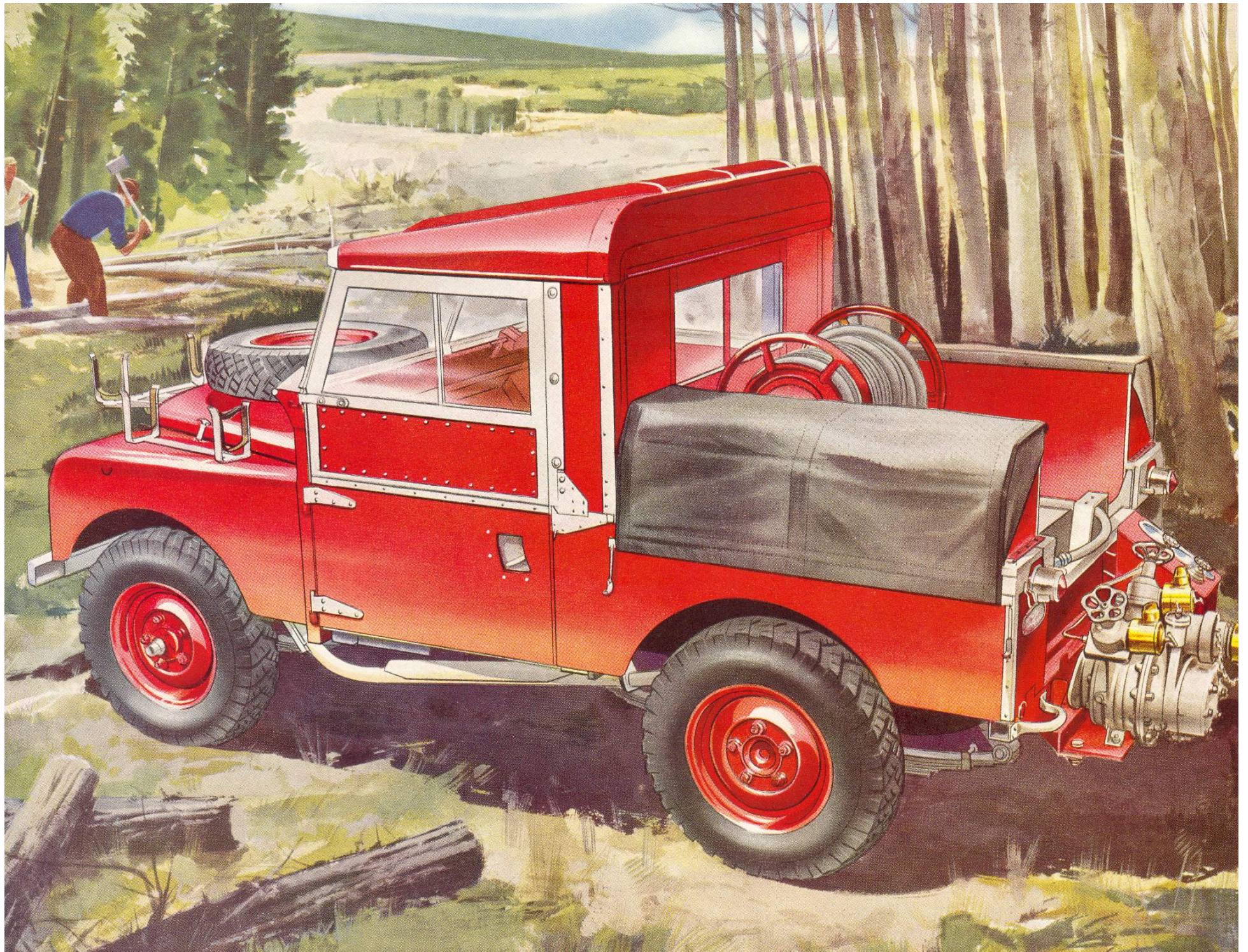

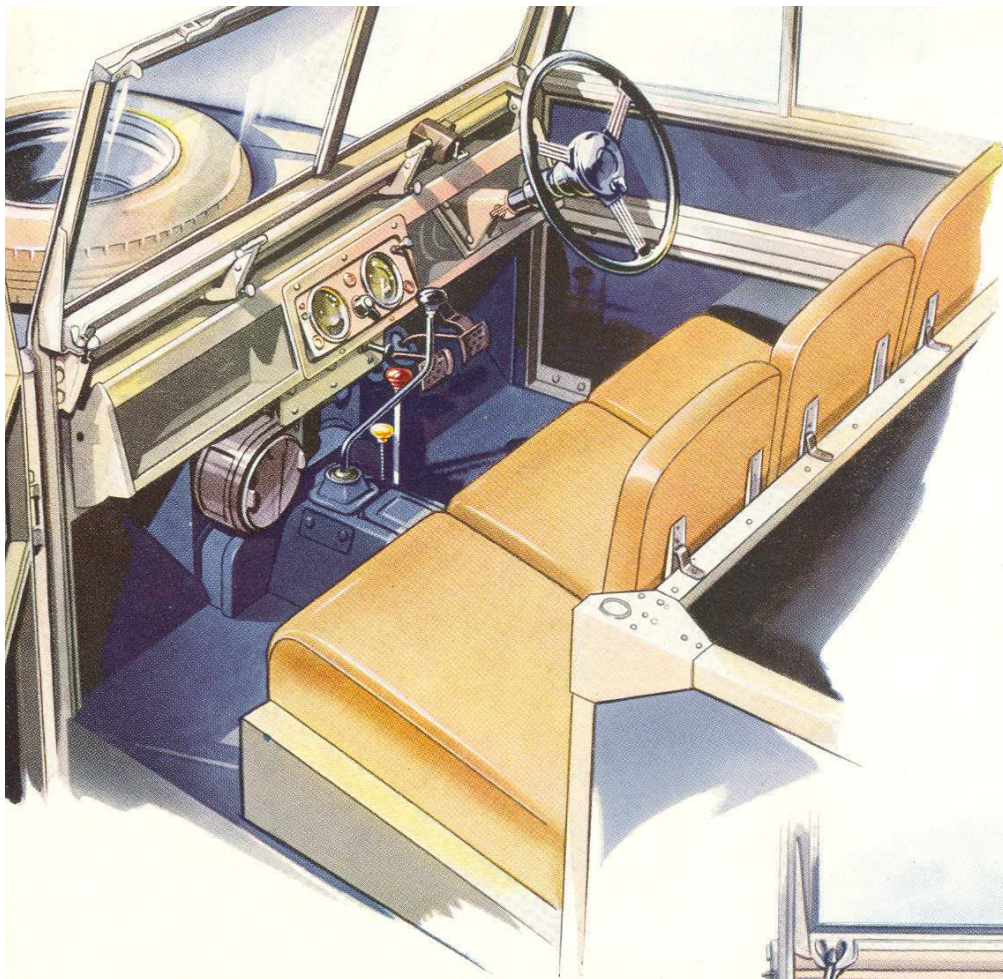

A recirculatory type of heater can be supplied as an optional extra. It fits neatly under the dash and operates efficiently to give ample warmth in the coldest weather. Attachments are provided for windscreen defrosting.

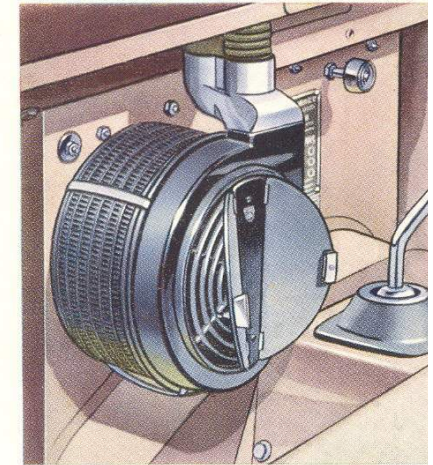

B O D Y F E

The Land-Rover driving compartment offers excellent accommodation for three people and provides comfort and roominess unequalled in a vehicle of this type.

Pedals and levers are so arranged that drivers of any stature may easily operate them, while the positioning of the seats gives a very high degree of vehicle control.

There is good forward visibility through the deep, two-piece toughened glass windscreen.

Left-hand steering can be fitted if required.

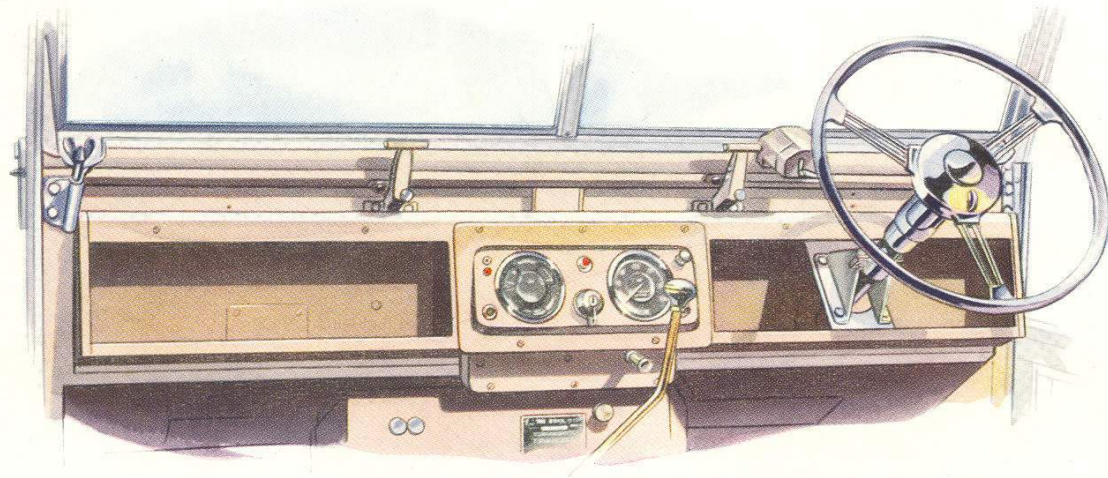

The centrally mounted instruments can be read at a glance, while dash compartments on either side provide very useful storage for all kinds of small articles.

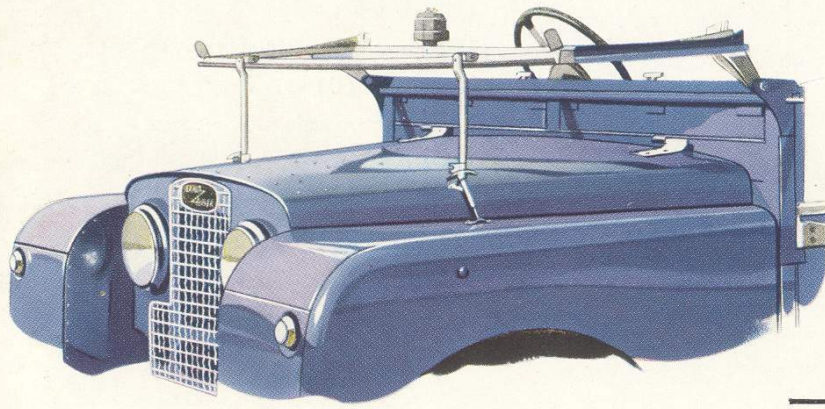

When required, the windscreen can be folded forward. It is held in this position by supports which are secured by the bonnet catch on each side.

FEATURES

Provision for carrying the spare wheel and tyre can be made either inside the body or on the bonnet, whichever is the more suitable position for the vehicle concerned or for the particular duties it has to perform.

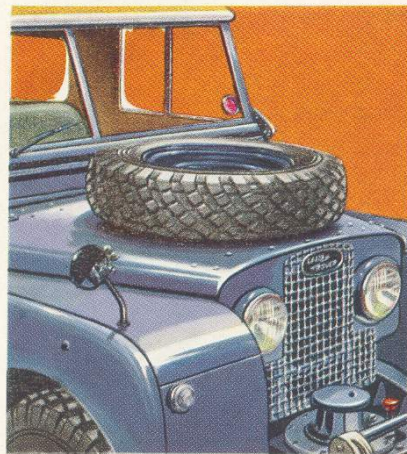
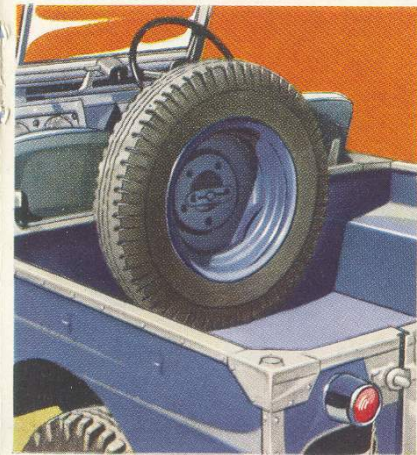

Open Land-Rovers are provided with a tailboard which can be lowered into the horizontal position to facilitate loading and unloading.

The detachable hard-top has a lift-up type of door at the rear. With the vehicle tailboard lowered ample loading facilities are afforded.

A wide rear door and folding step give easy access to the rear seats of the Land-Rover Station Wagon. The door is lockable.

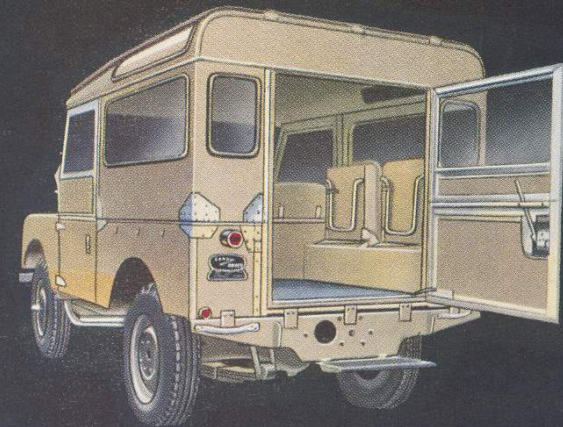
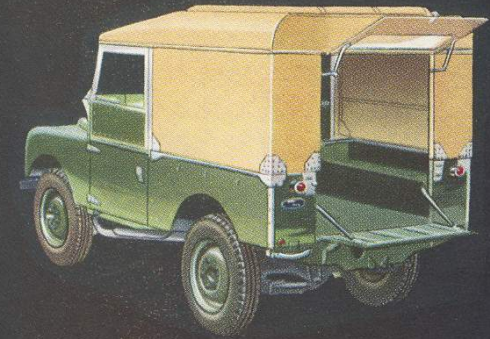
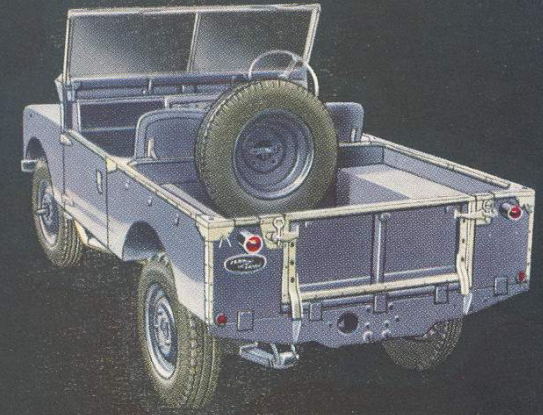

RUGGED CONSTRUCTION

The Land-Rover chassis is a rugged structure of great strength that will stand up to the stresses and strains of its go-anywhere, do-anything duties. The frame itself is of welded box section construction having great torsional and diagonal rigidity. It is painted both outside and inside to resist corrosion. The whole chassis unit is of straightforward design for easy maintenance and replacement of parts.

CHASSIS

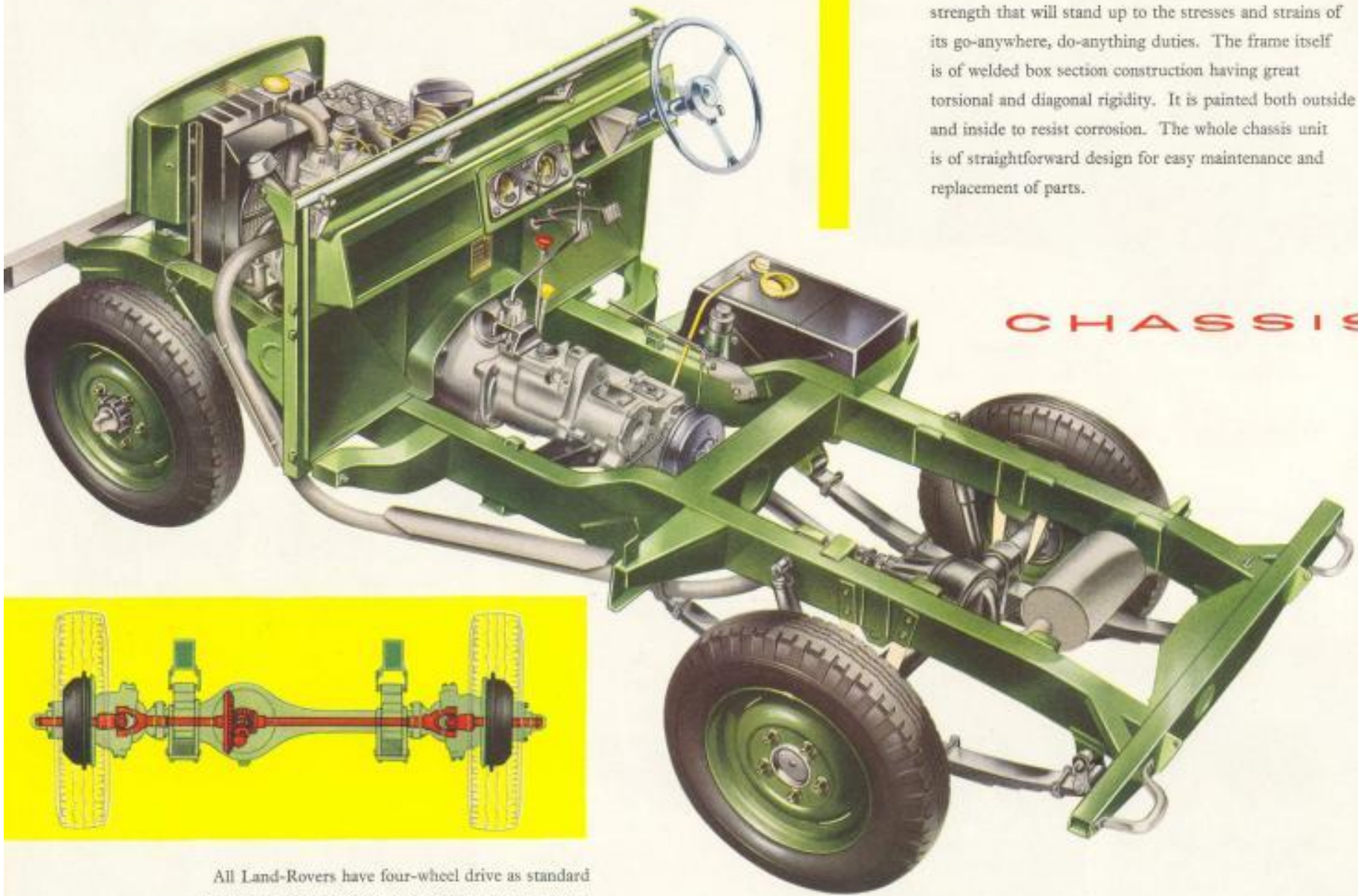

All Land-Rovers have four-wheel drive as standard equipment, front and rear axles being of robust spiral bevel design.

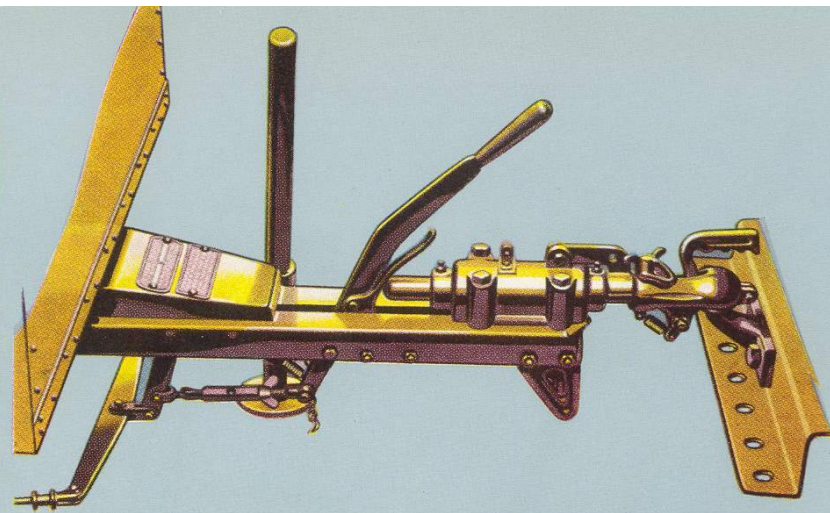
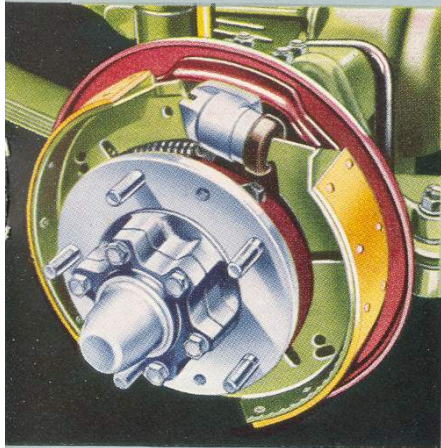

Land-Rover brakes are hydraulically operated. Leading and trailing shoes are used for 86 in. wheelbase models, while 107 in. wheelbase vehicles employ two-leading shoes on front wheels.

A towing bar can be supplied as an optional extra. It provides a simple but effective means of securing a trailer attachment.

8 DETAILS

Suspension is an important matter on a vehicle that must carry out so many duties in so many different kinds of territory. Land-Rover springs have, in fact, been specially graded to combine the riding qualities required for main road travel with ample toughness for hard work over rough ground.

They are supplemented by telescopic hydraulic shock absorbers which give highly efficient control.

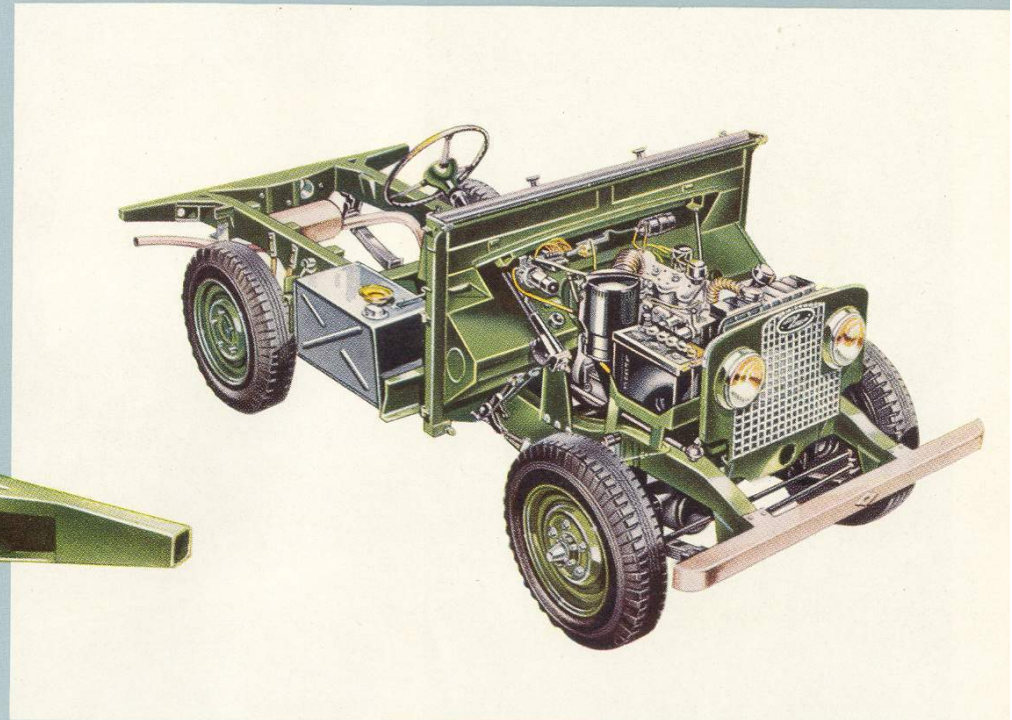
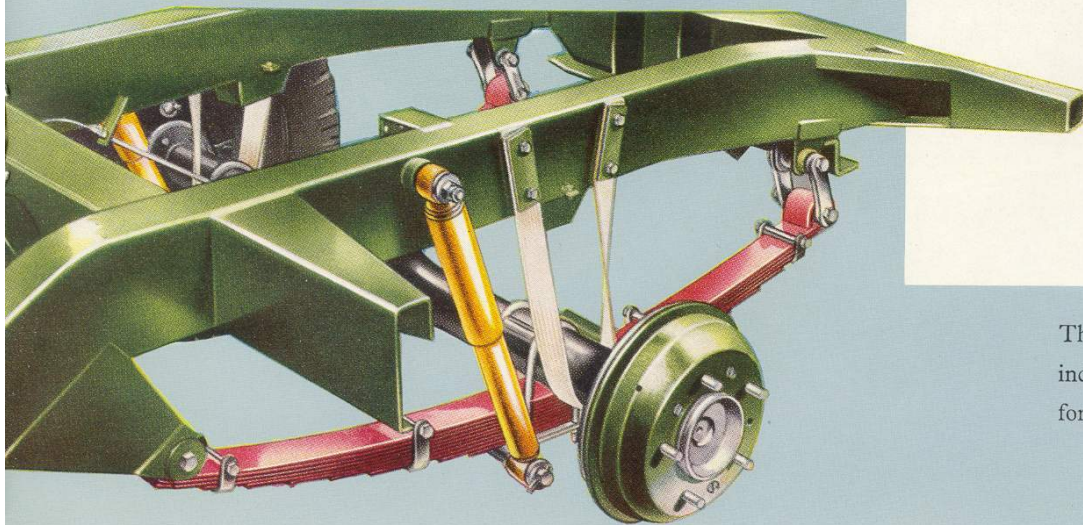

The layout of the engine compartment is compact yet the individual units are so placed that they are readily accessible for maintenance and adjustment.



POWER UNIT . . .

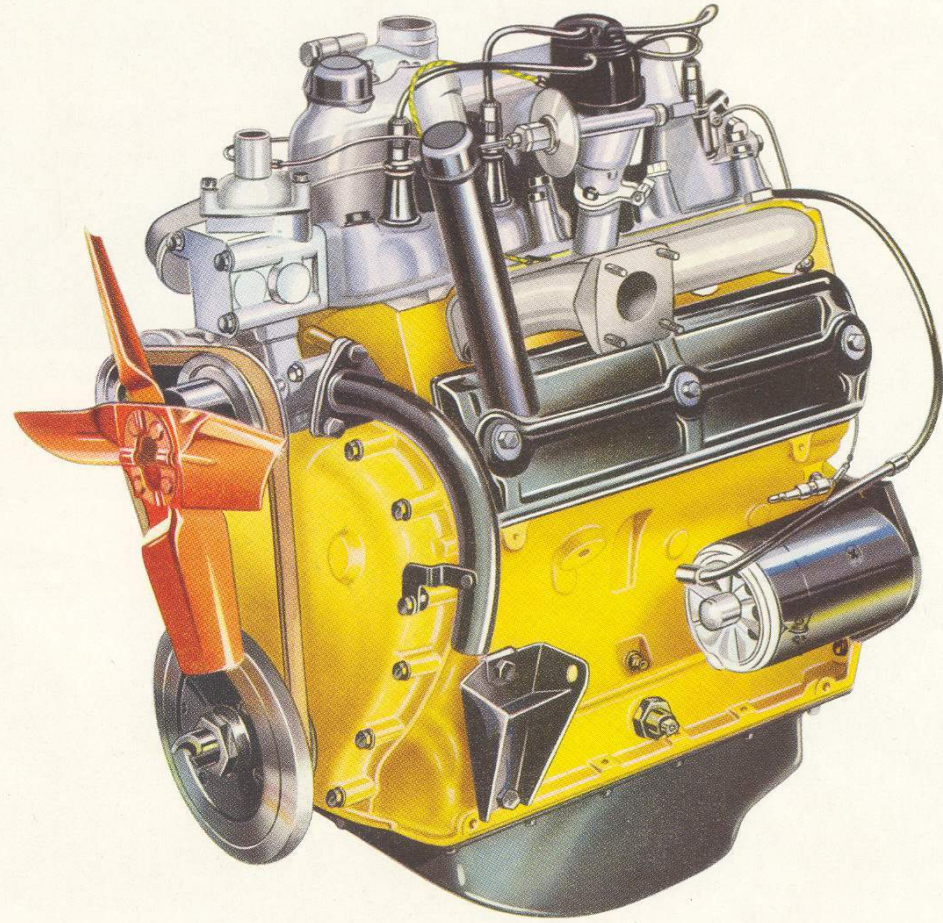
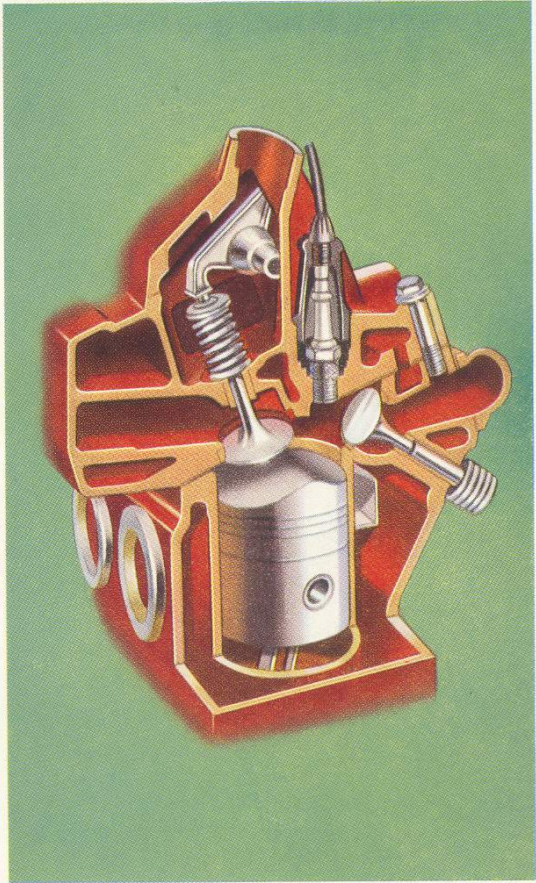

Power for vehicle operation, power for hauling trailers, power for driving machinery. Power that is smooth and willing for normal work ; slogging determined power for the tough jobs. The overhead inlet and side exhaust valve design of the Land-Rover engine ensures that all this power is developed with maximum efficiency and economy. It is a reliable unit, its robust construction giving it a long, trouble-free service life.

OF ROBUST DESIGN

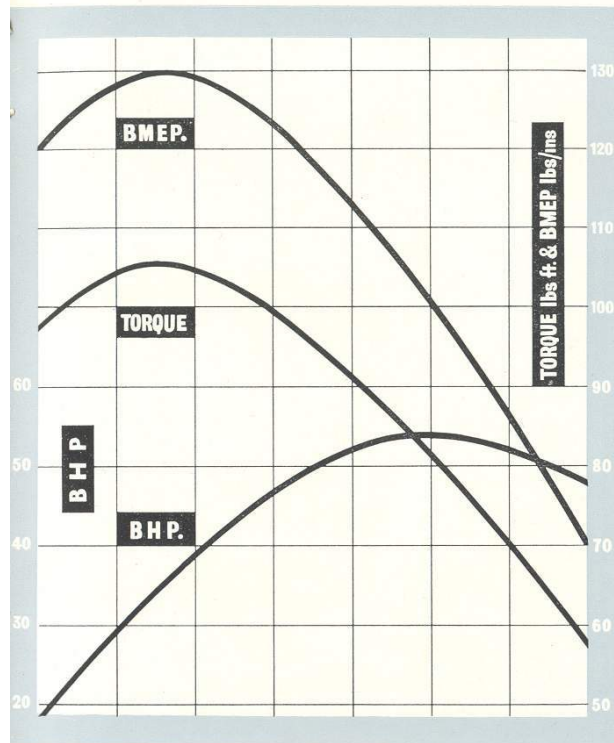

As shown on the graph above, the Land-Rover engine develops 52 b.h.p. at 4,000 r.p.m., while the excellent torque figure of 101 lb./ft. at 1,500 r.p.m. represents outstanding pulling power at low revs. The cubic capacity of the unit is 1,997 c.c. and its compression ratio is 6.9 to 1.

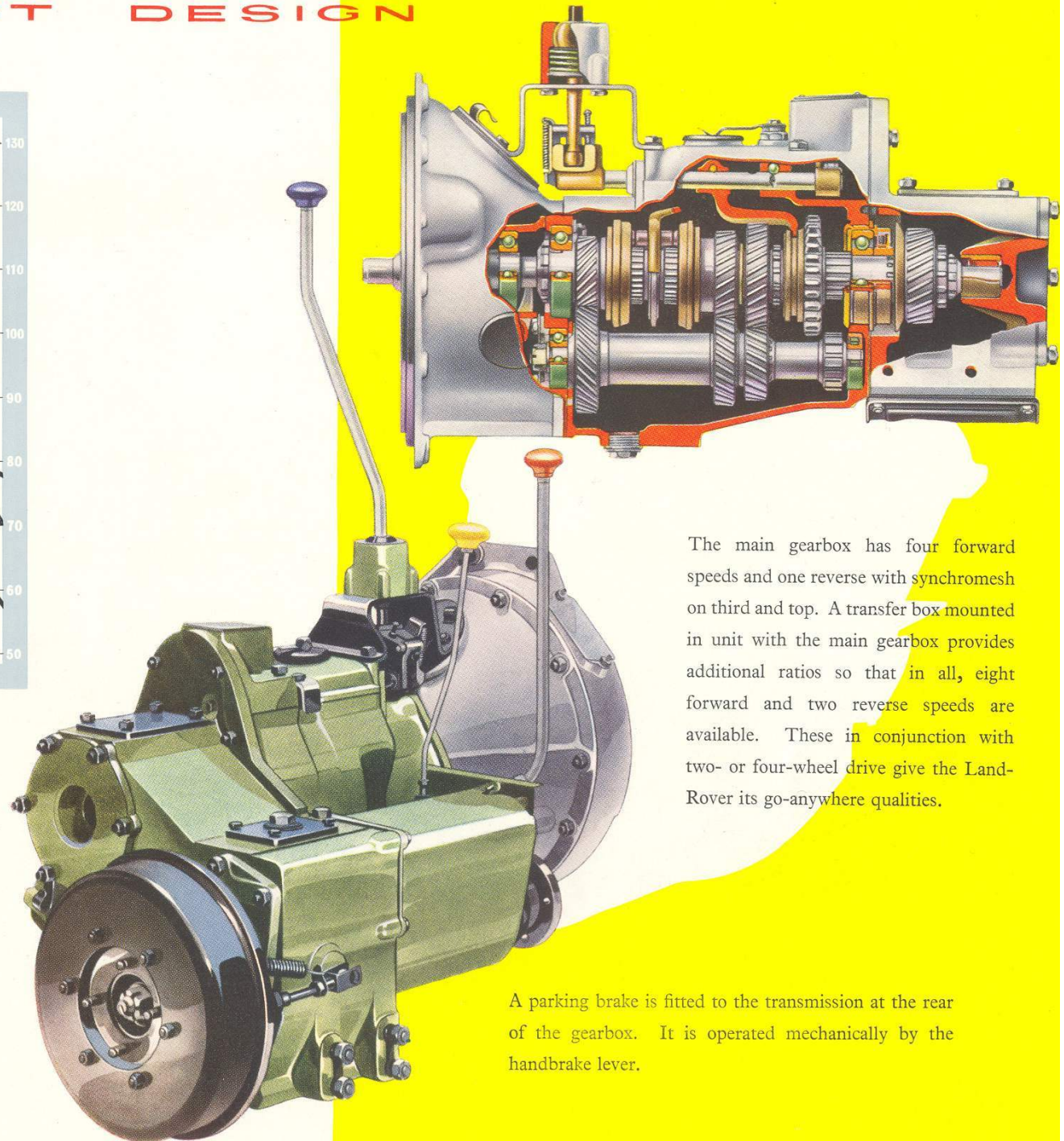

The main gearbox has four forward speeds and one reverse with synchromesh on third and top. A transfer box mounted in unit with the main gearbox provides additional ratios so that in all, eight forward and two reverse speeds are available. These in conjunction with two- or four-wheel drive give the Land-Rover its go-anywhere qualities.

A parking brake is fitted to the transmission at the rear of the gearbox. It is operated mechanically by the handbrake lever.

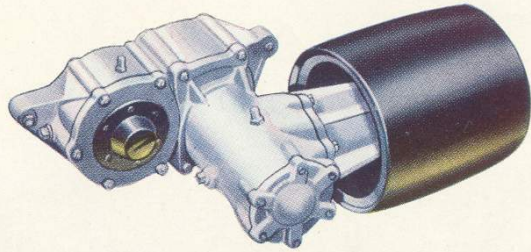

Rear power take-off pulley unit which provides a flat belt drive for standing machinery.

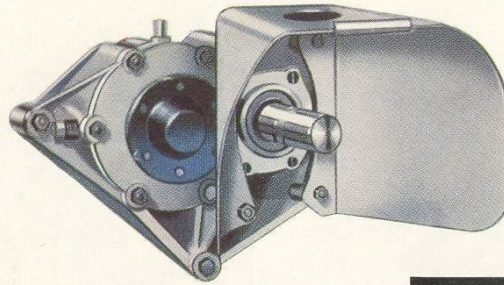

Rear power take-off drive section for operating, through a splined shaft, machinery towed by the vehicle.

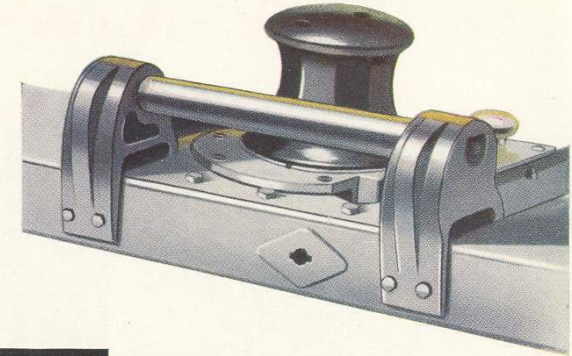

A capstan winch can be fitted to the front of the Land-Rover for recovery and haulage work.

Power Take - off

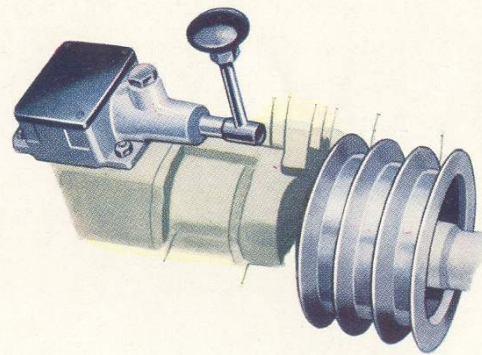
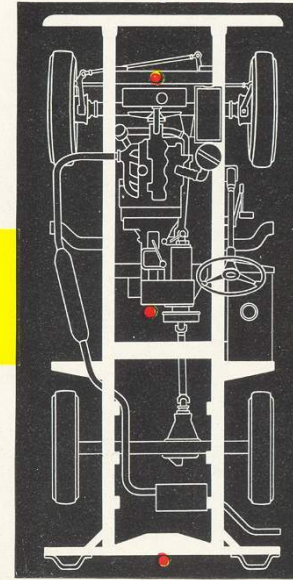

Centre power take-off may be used to operate an appliance mounted in the body of the vehicle.

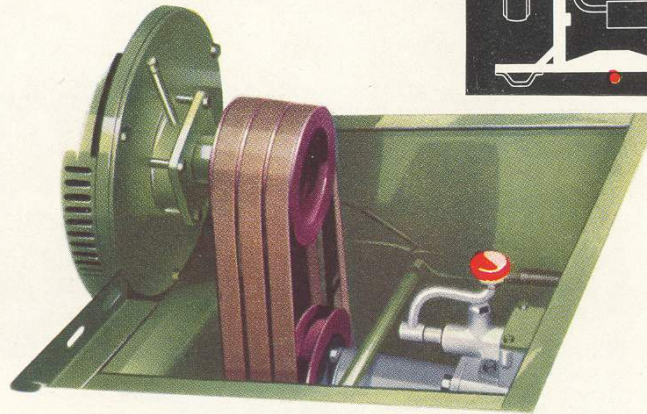

Showing the three-pulley drive of the centre power take-off unit in operation.

The versatility of a Land-Rover is greatly enhanced by its ability, not only to go anywhere, but to drive many forms of machinery. Power take-off units are available at extra cost and the chief types are illustrated on this page.

To complete the impressive Land-Rover picture a wide range of body extras can be supplied. For instance, a detachable metal body cover or separate metal cab is available for the 86 in. wheelbase model to give extra weather protection, while a tropical roof can be fitted to vehicles destined for hot countries. And there are many other optional items that may be added. Everything, in fact is provided to make the Land-Rover body suitable for the greatest possible number of uses.

A de luxe cab is an optional extra on the 107 in. wheelbase Land-Rover. With trimmed door casings and carpets it affords a very high standard of comfort for driver and passengers.

A detachable metal top can be fitted to 86 in. wheelbase models. Note that side windows are for export models only.



Optional body Equipment

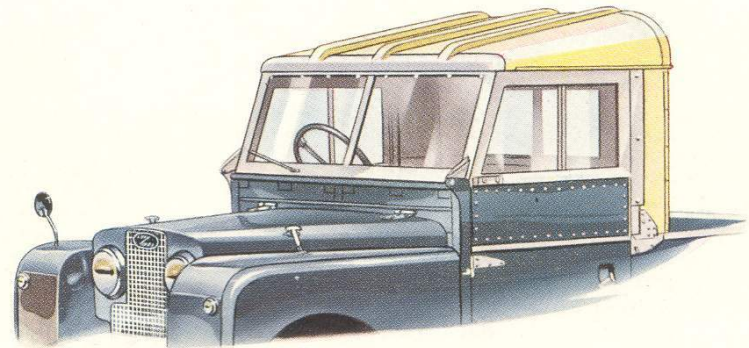
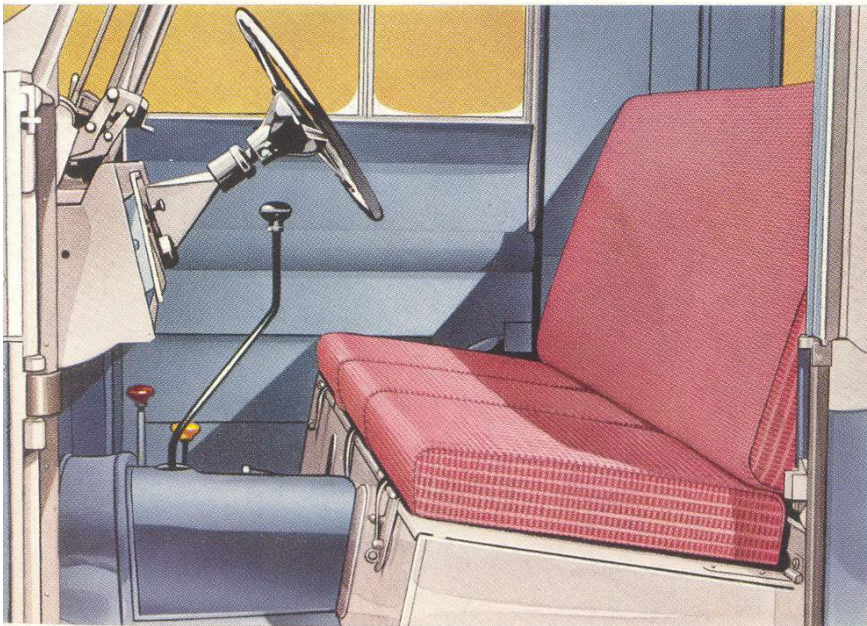

Truck type cabs are fitted as standard equipment on the long wheelbase model but can also be supplied as an optional extra on the 86 in. wheelbase vehicle. A tropical roof is available for this type of unit.

THE **4** WHEEL DRIVE



Chassis

Engine

GENERAL

Four cylinders. Overhead inlet valves, side exhaust valves. Bore and Stroke : 77.8 mm. (3.063 in.) × 105 mm. (4.134 in.).
Cubic Capacity : 1,997 c.c. (121.8 cu. in.).
B.H.P. (Max.) : 52 at 4,000 r.p.m.
Torque (Max.) : 101 lb./ft. (14 m. kg.) at 1,500 r.p.m.

Compression Ratio : 6.9 : 1.

Cylinders : Monobloc, cast integral with crankcase.

Cylinder Head : Detachable, cast iron and carrying inlet valve gear.

Inlet Valve Operation : By rockers, tubular push rods and cam followers.

Exhaust Valve Operation : By rockers direct on to valve stems.

Crankshaft : Forged steel. Fully balanced and with counter-weights.

Main Bearings : Three, thin shell, steel-backed copper-lead. Thrust taken at centre bearing.

Camshaft : Forged steel. Four bearings, split Mazak die castings. Drive by Duplex roller chain. Chain tension maintained by self-adjusting jockey sprocket controlled by coil compression spring and oil pressure.

Pistons : Low expansion aluminium alloy, tin plated. Two compression rings, one stepped scraper ring and one slotted scraper ring. Fully floating gudgeon pins.

Valves : Inserted valve seats.

Exhaust : XB steel with Bright Ray facing.

Inlet : Silchrome No. 1 Steel.

The location of inlet valves in the cylinder head and exhaust valves in the cylinder block gives advantages such as :

Greater area of inlet valve.

Closer relation of water jacket to exhaust valve.

More direct induction system.

Most efficient location of sparking plug.

Part-spherical combustion chamber promoting turbulence and more thorough burning of mixture.

More efficient scavenging.

Connecting Rods : Forged steel with thin shell steel-backed copper-lead big-end bearings.

LUBRICATION SYSTEM

By submerged gear type pump driven from camshaft. Oil delivered to main, big-end and camshaft bearings under a running pressure of 55-65 lb./sq. in. Tubular oil gallery, inserted in the crankcase supplying the oil feed for the camshaft bearings, exhaust valve gear, and the inlet valve gear in the head. Gauze pump intake filter in the sump ; removeable full-flow external oil filter.

Oil Filler : Integral with exhaust valve rocker cover and incorporating oil-wetted gauze breather. Similar breather fitted to inlet valve rocker cover.

Sump Capacity : 10 pints (5.68 litres). Level determined by dipstick.

COOLING SYSTEM

Pump operated and thermostat controlled. Water pipe inserted in block directs water to the points of highest temperature.

Pump : Centrifugal type, belt driven, mounted on front end of cylinder block.

Radiator : Film block type.

Fan : Four bladed, mounted on water pump spindle and both driven by common belt. Belt tensioned by pivot mounted dynamo method.

Thermostat : A.C. bellows type.

Capacity of System : 17 pints (9.66 litres).

FUEL SYSTEM

Separate induction manifold.

Carburettor : Solex downdraught type 32 PB 1-2.

Fuel Pump : S.U. Electric.

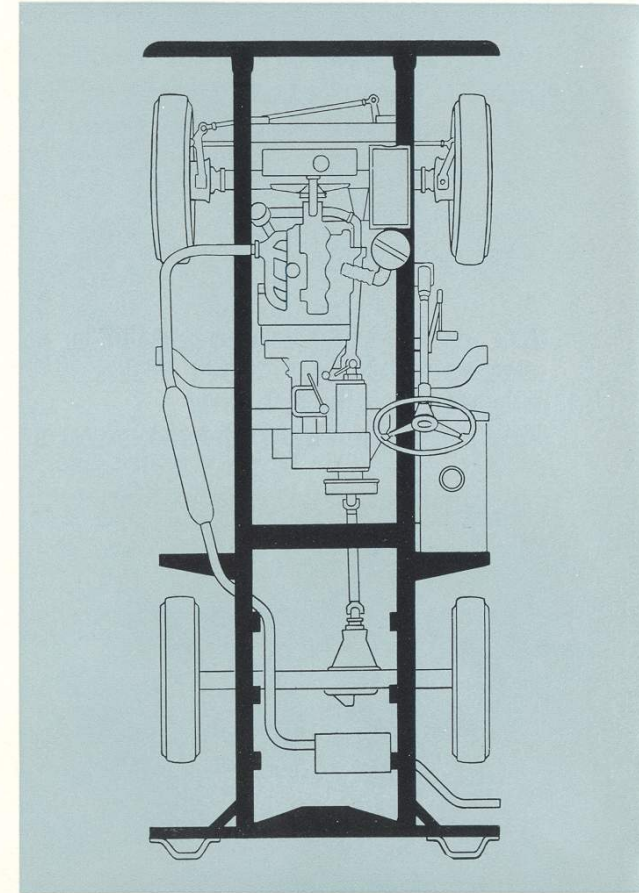

and Engine Specification

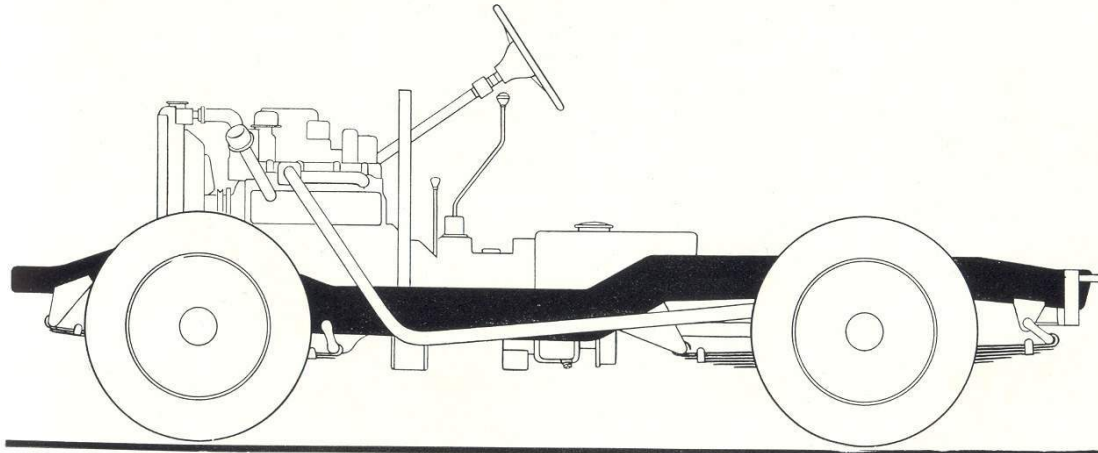

Air Cleaner and Silencer : A.C. large capacity oil bath type, with built-in pre-cleaner.

Petrol Tank : Carried outside side-member under right-hand seat and fitted with protective underplate. Electric petrol gauge fitted.

Filler : Telescopic filler tube and filter to facilitate filling from can. Filler cap incorporates air vent. Provision for padlock to secure the tank contents.

Tank Capacity : 10 gallons (45.46 litres).

EXHAUST SYSTEM

Silencer : Flexibly mounted transversely behind rear axle.

Tail Pipe : Integral with silencer.

IGNITION SYSTEM

Coil ignition. Lucas 12 volt.

Distributor : Driven from camshaft. Automatic advance and supplementary vacuum control.

Sparking Plugs : Lodge long reach 14 mm.

ENGINE UNIT MOUNTING

Flexibly mounted on bonded rubber at four points, two at front of crankcase and two on transfer box.

Transmission

CLUTCH

Single dry plate type. 9 in. (0.23 m.) diameter. Spring cushion drive. Fitted in enclosed bell housing in which is mounted clutch operating shaft and levers. Light operating pressure.

Clutch Operation : Clutch pedal mounted on frame and operating through adjustable linkage. Control shafts lubricated by oil gun through nipples.

Clutch Withdrawal Thrust : Ball thrust race enclosed in special housing and fully lubricated.

MAIN GEARBOX

Four forward speeds, one reverse.

Synchromesh : Top and third gears.

Overall Ratios, including Axle : First 16.171 ; second 11.026 ; third 7.435 ; top 5.396 ; reverse 13.745.

Gear Change : By direct central ball change lever on top of gearbox.

Oil Capacity : 2½ pints (1.42 litres).

TRANSFER GEARBOX

Giving a reduction on the output from the main gearbox and providing additional overall ratios as follows : first 40.688 ; second 27.742 ; third 18.707 ; top 13.578 ; reverse 34.585.

Transfer Gear Change : By independent lever, also giving intermediate neutral position.

Speedometer Drive Gear : Incorporated with output shaft of transfer gearbox.

Oil Capacity : 4½ pints (2.56 litres).

FOUR WHEEL DRIVE

Automatically selected when transfer box low ratio is engaged. Drive to front axle optional with high ratio engaged. Selected by an independent lever.

POWER TAKE OFF

Centre and rear power take-off drives available as optional extras except on Station Wagons.

PROPELLER SHAFTS

Hardy Spicer open propeller shafts to front and rear axles.

Lubrication : By oil gun through nipples.

REAR AXLE

Semi-floating type. Spiral bevel drive in banjo type axle case.

Ratio : 4.7 : 1.

Bevel Pinion Bearings : Taper roller journal, preloaded.

Hub Bearings : Single row ball journal. Fitted with oil seals.

Oil Capacity : 3 pints (1.70 litres).

Specification

FRONT AXLE

Fully-floating type. Spiral Bevel drive in banjo type axle case.

Ratio : 4·7 : 1.

Bevel Pinion Bearings : Taper roller journal, pre-loaded.

Hub Bearings : Taper roller journal.

Angularity of Universal Joint at Full Lock : 26°.

Oil Capacity, Differential : 3 pints (1·70 litres).

Oil Capacity, Universal Joint Housing : 1 pint (0·57 litre).

ROAD SPEED

In m.p.h. at 1,000 r.p.m. : first 5 ; second 7·34 ; third 10·9 ; top 15.

Suspension

Springs : Semi-elliptic type, underslung. Silent-bloc bushes all round. Second leaves wound round shackle pin eye to give extra strength.

Shock Absorbers : Monromatic double-acting telescopic type.

Steering

Burman worm and nut type. Thrust adjustment by nut at top of column.

Ratio : 15 : 1.

Steering Wheel : 17 in. (0·43 m.) diameter. Spring spokes. Cellulose acetate covering. Fitted with horn push button and dip switch at centre.

Relay Unit : Consists of spring loaded Tufnol damping cones.

Drag Link, Track Rod, and Longitudinal Tube : Tubular, with non-adjustable ball joints requiring no lubrication.

Turning Circle : 86 in. wheelbase with 6·00 × 16 tyres—37 ft. (11·28 m.) diameter. 107 in. wheelbase with 7·00 × 16 tyres—48½ ft. (14·78 m.) diameter.

Brakes

Foot Brake : Girling hydraulic.

86 in. wheelbase—leading and trailing shoes all round. Size of brakes 10 in. × 1½ in. (25·4 cm. × 3·8 cm.). Lining area 104·7 sq. in. (677 sq. cm.). 107 in. wheelbase—two leading shoes on front brakes, leading and trailing shoes on rear brakes. Size of brakes 11 in. × 2¼ in. (27·9 cm. × 5·7 cm.). Lining area 133·8 sq. in. (864 sq. cm.).

Hand Brake : Internal expanding transmission type at rear of gearbox. Girling mechanical actuation.

Hand Brake Lever : Extending forward horizontally from seat box and accessible to driver's hand.

Stop Light Switch : Operated mechanically from brake pedal shank.

Frame

Welded fabricated box section with box section cross-members, providing great torsional and diagonal rigidity.

Body Mounting : On outriggers welded to side-members.

Bumper : Bolted to front dumb-irons. Channel section, heavily galvanized.

Electrical Equipment

Dynamo : 12 volt Lucas. Fan ventilated. Compensated voltage control. Belt driven.

Battery : Lucas 12 volt. 51 A.H. Carried under bonnet.

Ignition Coil : Lucas. Mounted on engine side of scuttle.

Starter : Lucas type. Control by direct push switch situated below fascia.

INSTRUMENTS AND CONTROLS

Speedometer : Large diameter with total mileage recorder.

Petrol Gauge and Ammeter : Combined in large dial matching speedometer.

Electric Horn : Mounted under bonnet. Push button on steering wheel hub.

Electric Windscreen Wiper : Mounted on lower edge of windscreen frame. Switch on motor.

Panel Light : Illuminating speedometer, ammeter and petrol gauge. Switch does not operate unless side and tail lamp switch is closed.

Dip Switch : Mounted on steering wheel hub. Red warning lamp on ammeter and petrol gauge dial indicates high beam.

Ignition Switch : Operated by key and concentric with rotary switch for head, side and tail lamps.

Ignition Warning Light : Red.

Choke Warning Light : Amber.

Oil Pressure Warning Light : Green.

Headlamps : Mounted in radiator cowl. Twin filament bulbs for double dipping.

Side Lamps : Mounted on front wings.

Tail Lamps : Twin units having double filament stop/tail bulbs, incorporating number plate illumination.

Road Wheels

Pressed steel disc easy-clean type with ventilation slots. Five wheel studs.

Tyres : 86 in. wheelbase, basic equipment 6·00 × 16 dual purpose. 107 in. wheelbase, basic equipment 7·00 × 16, dual purpose.

Tools

Full kit of hand tools in roll. Starting handle, wheelbrace, oil gun, jack.

Body Specification

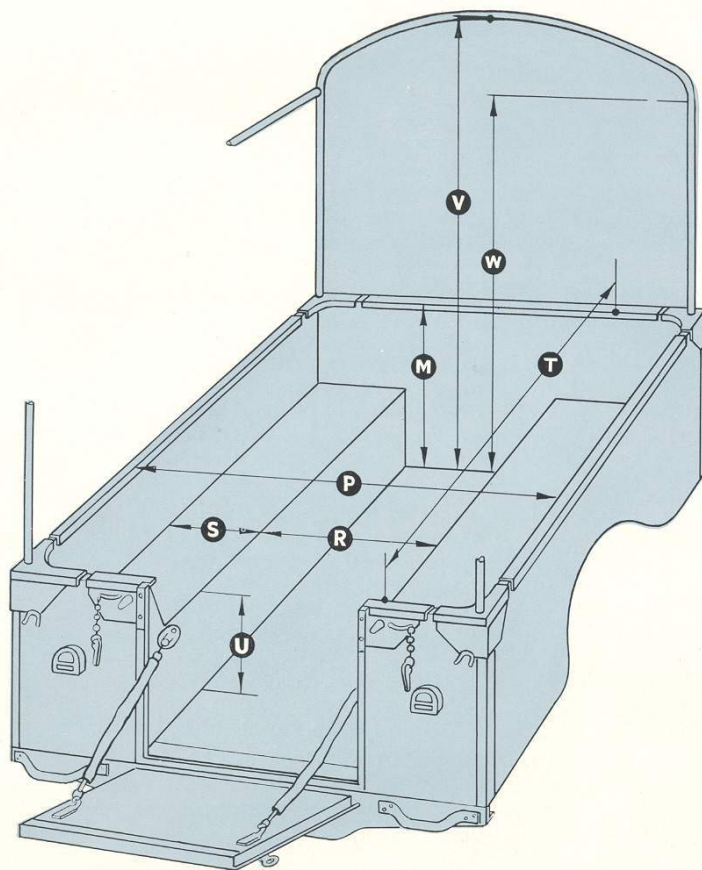

OVERALL DIMENSIONS	86 in. Wheelbase		107 in. Wheelbase	
	English	Metric	English	Metric
Wheelbase	86 in.	2.18 m.	107 in.	2.72 m.
Track	50 in.	1.27 m.	50 in.	1.27 m.
Ground Clearance	8 in.	0.20 m.	8 $\frac{3}{8}$ in.	0.22 m.
Turning Circle	37 ft.	11.3 m.	48 $\frac{1}{2}$ ft.	14.78 m.
Overall Length	140 $\frac{3}{4}$ in.	3.58 m.	173 $\frac{1}{2}$ in.	4.41 m.
Overall Width	62 $\frac{9}{16}$ in.	1.59 m.	62 $\frac{9}{16}$ in.	1.59 m.
Overall Height (max.)				
Station Wagon	76 in.	1.93 m.	78 in.	1.98 m.
Other Types	76 in.	1.93 m.	78 in.	1.98 m.
INTERNAL DIMENSIONS				
M	14 $\frac{1}{2}$ in.	0.36 m.	20 $\frac{1}{2}$ in.	0.52 m.
P	57 $\frac{1}{8}$ in.	1.45 m.	57 $\frac{1}{8}$ in.	1.45 m.
R	36 $\frac{5}{16}$ in.	0.92 m.	36 $\frac{5}{16}$ in.	0.92 m.
S	12 in.	0.30 m.	12 in.	0.30 m.
T	45 $\frac{11}{16}$ in.	1.16 m.	72 $\frac{3}{4}$ in.	1.85 m.
U	8 $\frac{11}{16}$ in.	0.22 m.	8 $\frac{11}{16}$ in.	0.22 m.
V	46 $\frac{1}{2}$ in.	1.18 m.	52 $\frac{3}{4}$ in.	1.34 m.
W	40 $\frac{3}{4}$ in.	1.04 m.	47 in.	1.19 m.
PAYLOADS				
86 in. Wheelbase	3 Persons+1000 lb. (453.6 kg.)			
107 in. Wheelbase	Roads: 3 Persons+1500 lb. (680.4 kg.)			
	Rough: 3 Persons+1200 lb. (544.3 kg.)			
107 in. Station Wagon	Roads: 10 Persons or 6 Persons+700 lb. (317.5 kg.)			
	Rough: 8 Persons or 6 Persons+400 lb. (181.4 kg.)			

THE ROVER COMPANY LTD.

SOLIHULL BIRMINGHAM ENGLAND

Telephone : Sheldon 2461.

Telegrams : Rover, Solihull.

Service Depot : SOLIHULL.

Telegrams : Rovrepair, Solihull.

London Showrooms : DEVONSHIRE HOUSE, PICCADILLY, W.1. Telephone : GROsvenor 3252.

London Service Depot : SEAGRAVE ROAD, FULHAM, S.W.6

Telephone : FULham 1221.

Telegrams : Rovrepair, Wesphone, London.

WHAT WILL THE LAND-ROVER DO?

It has already been established that Land-Rovers will go virtually anywhere, that they are powerful, economical to run, surprisingly comfortable to ride in and provided with a wide range of body and power take-off equipment. Furthermore, they are non-corroding and non-rusting, and may therefore be operated continuously in every sort of climate and over the most appalling ground conditions.

These facts indicate an almost unlimited field of operation for the world's most versatile vehicle, and the following list showing some of the uses to which the Land-Rover has actually been put will provide ample proof of its "do-anything", "go-anywhere" powers.

Land-Rovers are taking a very active part in the sphere of agriculture and will efficiently undertake the following duties :

GENERAL

Hay Sweeping.	Crop Spraying and Dusting.
Pumping.	Tree Felling and Ground Clearance.
	Transporting Stock to Market.

TOWING

Cultivators.	Water Trailers.	Harrows.
Horse Boxes.	Rollers.	Fertilizers.
Gang Mowers.	Horse Rakes.	Binders.
	Two- and four-wheeled Load Carrying Trailers.	
	Combine Harvesters	

TOWING AND DRIVING

Rick Elevators.	Hammer Mills	Mobile Milking Machinery.
Silage Blowers.	Hedge Cutters.	Saw Benches.
Compressors for Paint Sprayers, Scaling Tools, Riveters, etc.		

TYPICAL USERS

Agricultural Development Teams.	Botanical Survey Teams.
Colonial Soil Survey Teams.	Forestry Commissions.
Game Wardens.	Game Preservation Units.
Estate Supervisors.	Dairy Companies.

Agriculture is however only one sphere of Land-Rover usefulness, for it plays a great many other parts. Some of its more interesting tasks include :

Mountain Rescue.	Malarial Control.
Colonial Development.	Public Works.
Education.	Tsetse Fly Control.
Fire Fighting.	United Nations (UNESCO)
Ambulance Service.	Water Supply.
Geological Survey.	World Health Organisation.
Highway Maintenance.	Seismograph Service.
Exploration.	Oil Field Prospecting and Maintenance.
River Maintenance	Copper Mine Prospecting.
Irrigation Control.	Scientific and Industrial Research.
Locust Control.	

Land-Rovers also do important work for Government Departments, such as :

Customs and Excise.	Police Departments.
Coal Boards.	Post Offices.
Electricity Supply Boards.	Railways.
Fisheries Department.	Income Tax Inspectors and Collectors.
Labour Departments.	Crown Agents.
Lighthouse Authorities.	

The Armed Services of many countries operate large numbers of Land-Rovers which are outstanding for this type of work :

Great Britain	Navy, Army, Air Force.
New Zealand	Army, Air Force.
Uruguay	Ministry of National Defence.
Indo-China	Armee Royal Khmere, Forces Armees Hoa-Hoa, Garde Nationale du Nord-Vietnam.
Angola	Navy Station, Frontier Guard.
Ecuador	Ministry of Defence and Military Zone 2 Guayaquil.
Ethiopia	Ministry of War.
Australia	Navy.
Brazil	Navy, Army, Air Force.
Denmark	Military Service.
Malaya	Security Forces.
Lebanon	Army.
Jordan	Arab Legion, Royal Palace Guard.
Iran	Army.
Casablanca	Auxiliary Forces.
Belgium	Army.
Holland	Navy, Marines.

In addition, Land-Rovers are used by the Police Forces of the following territories :

Mauritius.	Martinique.	Thailand.
Trinidad.	Turkey.	Nigeria.
Uruguay.	Lebanon.	Indo-China.
Kenya.	Angola.	Uganda.
Ecuador.	Tanganyika.	Ethiopia.
Bahrain.	Hong Kong.	Saudi Arabia.
Iran.	French West Africa.	Brazil.
Tunisia.	Gold Coast.	Belgium.
Canada (Royal Canadian Mounted Police).		Ceylon.

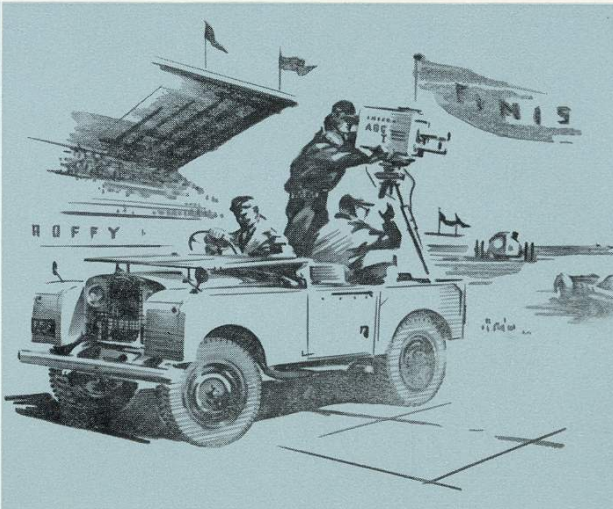
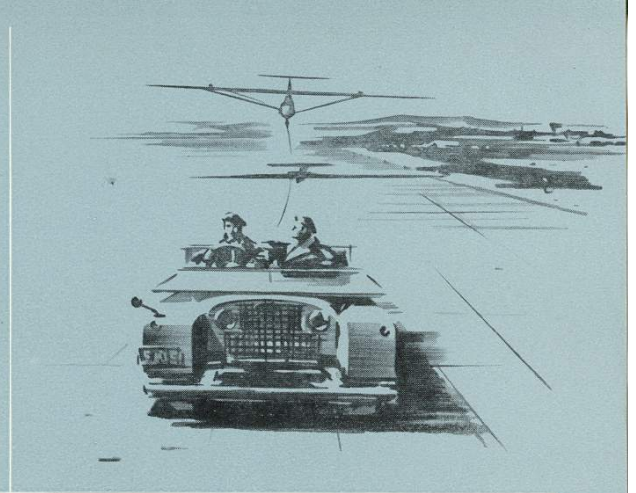
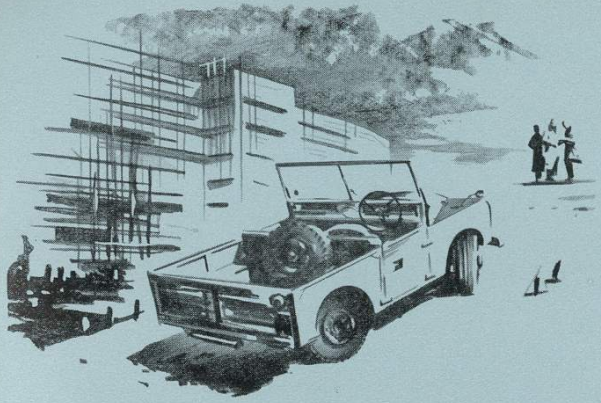

The Rover Company Limited reserves the right to alter specifications, colour, designs or prices without notice and without incurring any obligation. While every effort is made, in Rover literature, to provide information that is strictly up-to-date, no responsibility can be accepted for such alterations that occur after date of going to press. Persons dealing in the Company's goods are not the agents of the Company and have no authority whatsoever to bind the Company by any expressed or implied undertaking.

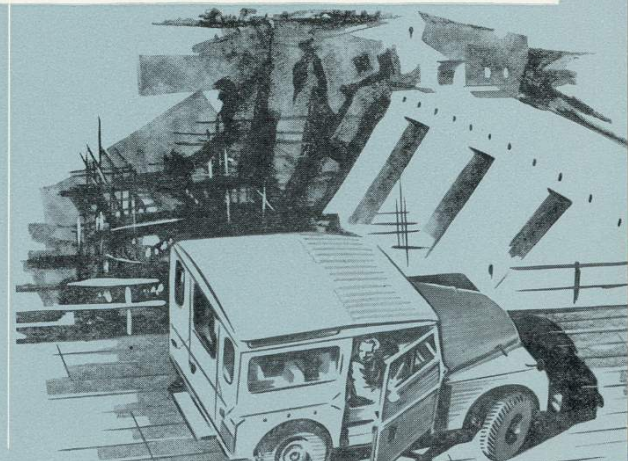



By appointment to Her Majesty Queen Elizabeth II
Manufacturers of Land-Rovers
The Rover Company Limited

THE WORLD'S MOST VERSATILE VEHICLE

LAND →
← **ROVER**

W. HOLLOWAY & SONS LTD.

MOTOR ENGINEERS

26-30 SIDBURY

WORCESTER