



FREELANDER

FREELANDER



LAND ROVER

VPII

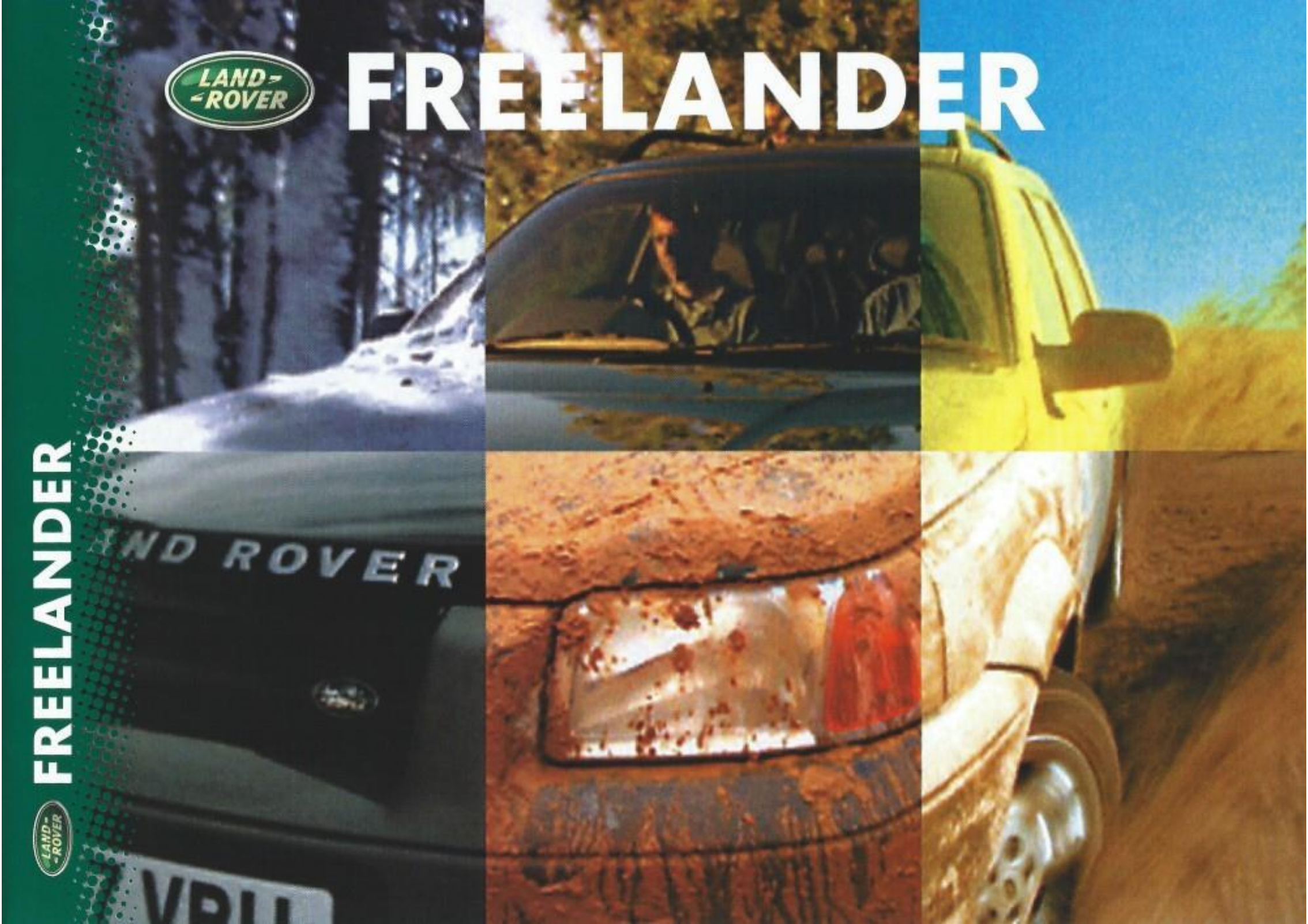



FREELANDER

THE LAND ROVER FOR YOU

At Land Rover we listen to our customers - and our potential customers. The result - Freelander, launched earlier this year, taking the market by storm and immediately carrying away the coveted 1998 'What Car?' Car of the Year Award. Freelander gives you everything you would expect from an accomplished family saloon with stunning style, robust safety and security, agility, smoothness and refinement. Plus, everything you would expect from a Land Rover Vehicle; a solid, tough off road 4x4 that stretches the imagination and extends your freedom to go where you want and to do what you want to do.

Like everything made by Land Rover, Freelander brings engineering innovation and revolution and a driving experience that will become a driving passion. Drive the dream - drive Freelander, the Land Rover you always wanted.



ON ROAD PERFORMANCE

INSPIRED HANDLING

There is no other vehicle in its class that bridges the breadth of capability both on road and off road like Freelander. On road you will experience ride comfort, handling and response second to none. The rigid, integral chassis optimises stiffness whilst reducing vehicle weight and, combined with the low centre of gravity, enhances stability. All round independent suspension with long wheel travel allied to the power assisted rack and pinion steering, soaks up the roughest roads and eases Freelander around the corners without dulling the senses. Of course Freelander, like all Land Rover vehicles, is a permanent 4x4 but under normal road conditions most of the power is channelled through the front wheels. Should conditions change Freelander's ingenious viscous coupling progressively distributes power between the front and rear axles safely regaining grip. Complete driving safety and comfort for you and your passengers.







LAND ROVER OFF-ROAD CAPABILITY

IN TOTAL CONTROL

Only a vehicle with genuine off road capability can carry the Land Rover badge and Freelander wears its badge with pride. The exhilarating experience that is Freelander goes on when the road ends bringing new freedom and the real chance to escape from it all. Dusty, rock-strewn paths; muddy, flooded tracks, snow covered mountain roads. All part of Freelander's expansive world. This solid Land Rover vehicle incorporates the latest in off road technologies. Hill Descent Control* maintaining a fixed 5.6mph when tackling steep, tricky descents slowing to 4mph when steering around obstacles. Fully automatic Electronic Traction Control* holding a surefooted grip and ensuring forward progress by sensing loss of traction in any given wheel and redistributing power to those with grip.

You're always in control with Freelander.

*Consult your dealer for availability.

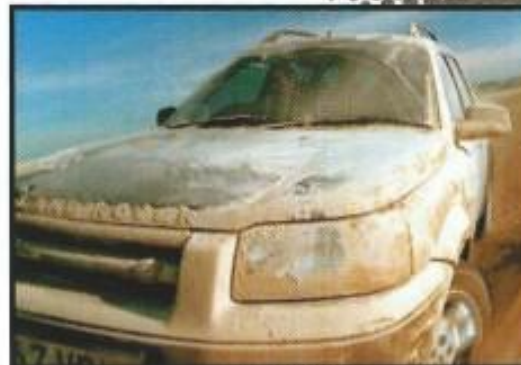



The Land Rover logo, featuring the words "LAND ROVER" in a stylized font inside an oval.

THE FREELANDER RANGE

FREEDOM OF CHOICE

The very essence of Freelander is the freedom to choose - what, where, when and how. Freelander is available as a 5 door Station Wagon, 3 door soft back and 3 door hard back. Freelander style is unique, picking up many of Land Rovers classic design cues. Ten body colours: solids, metallics and micatallics. The use of the latest polymers offering impact resistant bumpers, headlights and front wings.

A choice of power units; 1.8 litre petrol or 2.0 litre diesel with class leading performance and fuel consumption. Powerful enough to meet all your needs. Both petrol and turbo diesel models will tow up to an amazing 2000kg with a braked trailer.

A myriad of accessories, from alloy wheels, to lighting options, towing to touring; all rigorously tested and carrying the Land Rover Genuine Parts guarantee. You can adapt your Freelander to your precise requirement. Business or leisure there is a Freelander that will meet your needs and meet your desires.

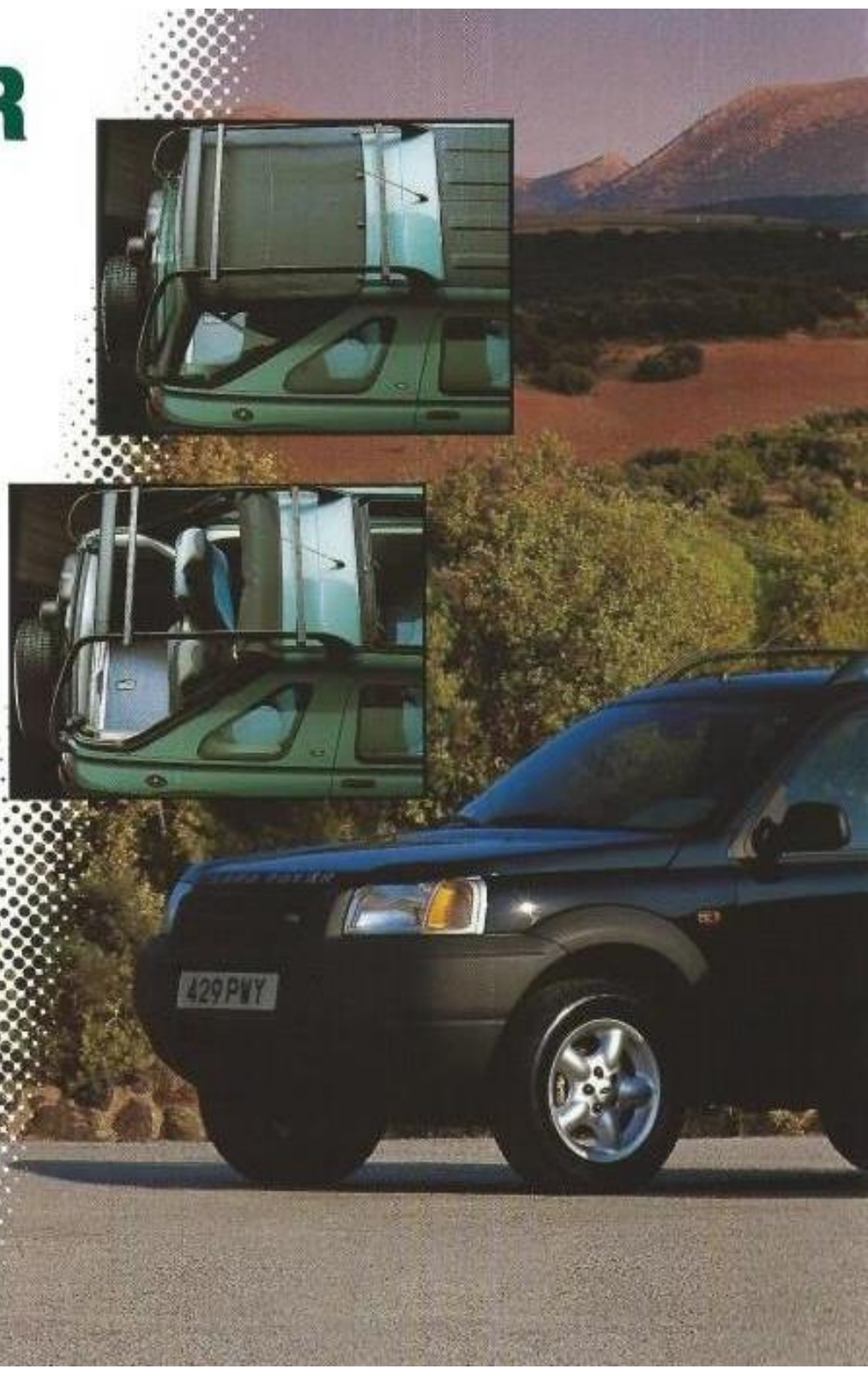





THE INTERIOR

DESIGNED-IN COMFORT

Whether you're driving with or without a roof, carrying passengers, carrying loads – or carrying both, Freelander has the versatility to do it all.

The 3 door and 5 door models offer the same in legroom, interior spaciousness and commanding seating position giving you a view out over the madding crowd. The three door comes with four bucket seats with the rears folding forwards to increase luggage capacity. A split folding three person rear seat with three diagonal belts and head restraints is optional on three door and standard on five door with a rear centre armrest. Furthermore, Freelander's unique exterior styling is carried through to the interior design offering a choice of trim colours on the unique, extrovert 3 door package and a different more luxurious 5 door interior. Storage is superb with door bins, overhead cargo nets and even flexible drinks holder. Drivers airbag, power steering and electric windows, together with Freelander's unique electric tail door drop glass are standard on all models.



3 DOOR

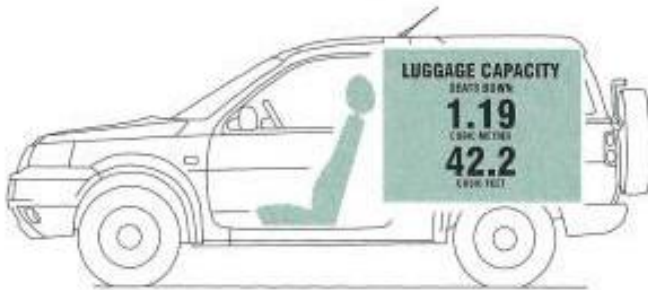
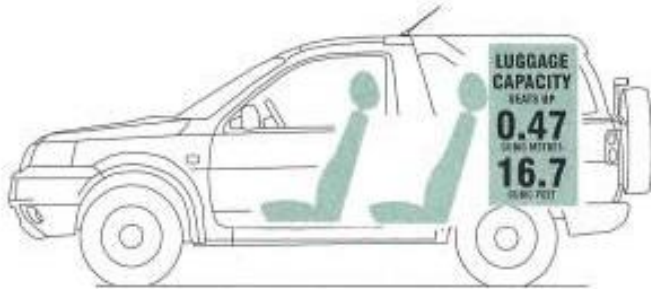

Interior dimensions all models

Maximum front leg room	1062mm
Minimum rear leg room	934mm
Front head room	977mm
Rear head room	968mm
Front shoulder room	1420mm
Rear shoulder room	1350mm

Loadspace volumes 3 door

To roof with seats up	473 litres
To roof – seats folded	1194 litres
To glass – seats up	311 litres
To glass – seats folded	610 litres
Underfloor locker	17 litres

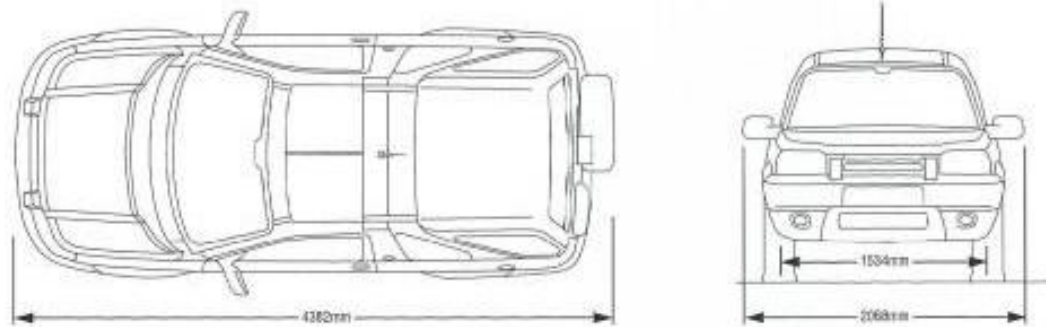
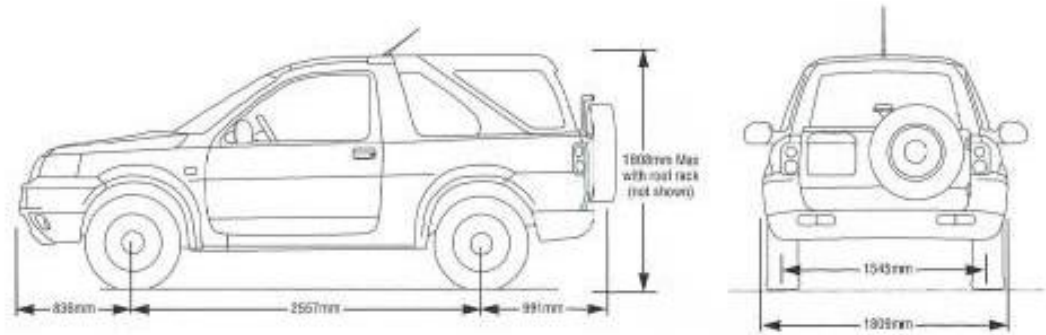

5 DOOR



Loadspace Dimensions all models

Height 5 door	922mm
Length seats up	441mm
Length seats folded	1059mm
Width	1400mm
Width between arches	978mm
Sill height	638mm
Door aperture width (min)	924mm
Door aperture width (max)	1086mm

Loadspace volumes 3 door

To roof with seats up	546 litres
To roof – seats folded	1319 litres
To glass – seats up	354 litres
To glass – seats folded	705 litres
Underfloor locker	17 litres

PHYSICAL CAPABILITY

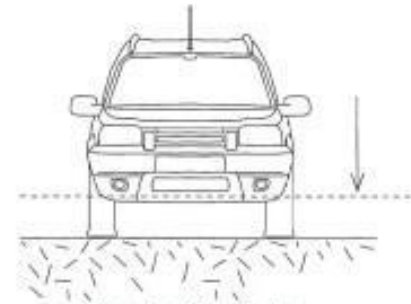

Clearing Obstacles

Minimum under axle:

Front axle: 186mm

Under body (min): 220mm

Rear Axle: 214mm

Front Suspension Articulation 180mm

Rear Suspension Articulation 240mm

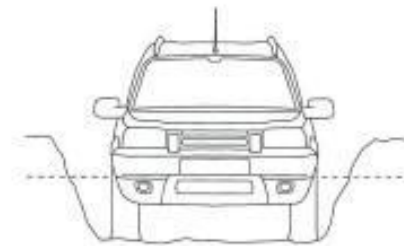

Wading Depth

Normal wading depth: 400mm

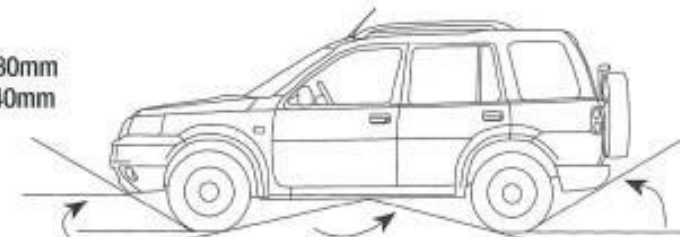

Approach Angle
30°

Ramp Angle
156°

Departure Angle
34°
(24° with Tow Bar)

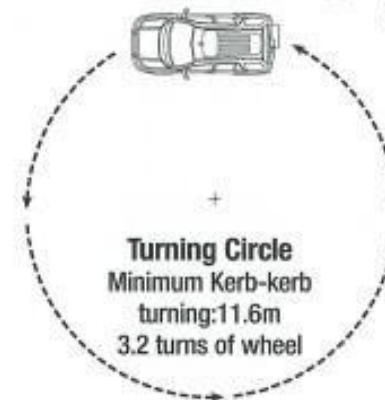

Turning Circle
Minimum Kerb-kerb
turning: 11.6m
3.2 turns of wheel



Hill Descent

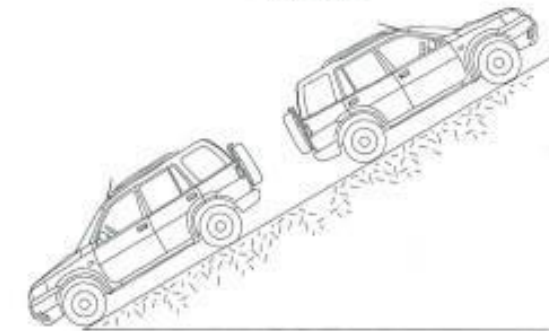

Hill Start

Max speed 5.6mph (when HDC applied)

33° Forward or Reverse



World of Land Rover

Around the world, the Land Rover brand stands for Freedom, Authenticity and Supremacy in 4x4 engineering and design. Every Land Rover vehicle is the leader of its class in performance, versatility and durability.

To choose a Land Rover is to choose adventure, individualism, and the sheer guts of the world's supreme 4x4 vehicle.

To enter the world of Land Rover is to enter a world of limitless capability.

Vehicle specifications and applied technologies vary across the vehicle models - please consult the specification pages for further details.

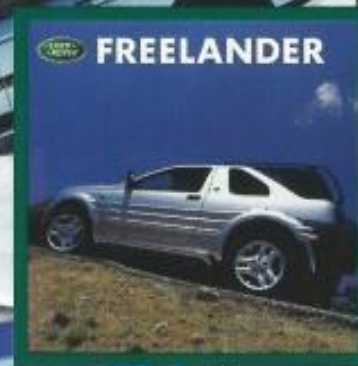
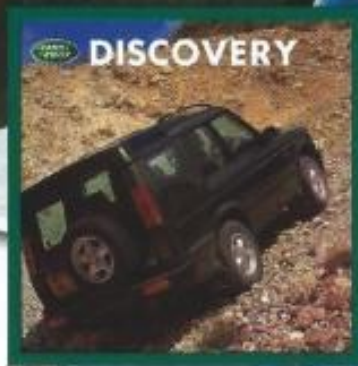
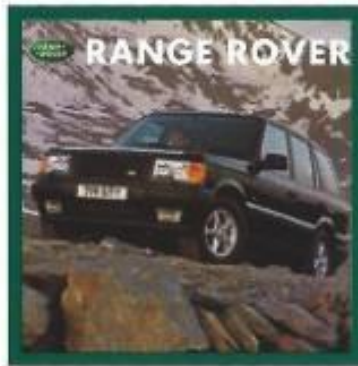



**LAND
-ROVER**



Whilst Land Rover take the utmost care in ensuring that all details in the publication are correct at the time of going to press, we are constantly striving for improvement and therefore reserve the right to alter specifications and equipment without notice. Details of specifications and equipment are also subject to change to suit local market conditions and requirements, and not all products are available in every market. Please consult your Land Rover dealer who will be pleased to advise you on current specifications. Distributors and dealers are not agents of Land Rover and have absolutely no authority to bind Land Rover to any express or implied undertaking or representation.



Environmentally conscious

In addition to delivering improved fuel economy and reduced CO₂ emissions, the Freelander uses only water-based paints. Whilst providing the highest quality paint finish, the spraying process reduces solvent emissions by over 50%.

Ozone depleting gases such as CFCs and HCFCs have been eliminated from all vehicle components and production processes.

Freelander's manufacturing process improvements have resulted in 30% reductions in CO₂ emissions and 41% savings in water usage per vehicle. (Between 1991-1998).

The Freelander design has been improved to facilitate easier disassembly, materials recycling and fluid drainage.

A true 'lifetime ownership' philosophy ensures that your Freelander satisfies all your driving needs.



THE BEST 4x4xFAR

Design and Photography:
Oakwood DC Ltd. 0117 983 6789

Production by The Drury Lane Company: 0121 627 5026

Printed on Grandeur Pure Art produced from
Totally Chlorine Free (TCF) pulp.



BY APPOINTMENT
TO HER MAJESTY THE QUEEN
MANUFACTURERS OF ROVER CARS
LAND ROVER AND RANGE ROVERS
ROVER GROUP LTD BIRMINGHAM



BY APPOINTMENT
TO HRH THE DUKE OF EDINBURGH
MANUFACTURERS OF
LAND ROVER AND RANGE ROVERS
ROVER GROUP LTD BIRMINGHAM



BY APPOINTMENT
TO HER MAJESTY THE QUEEN MOTHER
MANUFACTURERS OF LAND ROVERS
ROVER GROUP LTD BIRMINGHAM



BY APPOINTMENT
TO HRH THE PRINCE OF WALES
MANUFACTURERS OF
LAND ROVERS AND RANGE ROVERS
ROVER GROUP LTD BIRMINGHAM



Land Rover UK, International House, Bickenhill Lane, Bickenhill
Birmingham, B37 7HQ England
Tel: 0990 000 500, Fax: 0121-781-0253
www.landrover.co.uk

A division of the Rover Group Ltd

© Rover Group Ltd 1998

Pub No. LRF/357/98